



HY13-1527-M1/US

# Torqmotor™ Service Procedure

Effective: April 2015

---



TF, TG, TH and TL Series  
Low Speed, High Torque  
Hydraulic Torqmotors™

---

**WARNING**

FAILURE OR IMPROPER SELECTION OR IMPROPER USE OF THE PRODUCTS AND/OR SYSTEMS DESCRIBED HEREIN OR RELATED ITEMS CAN CAUSE DEATH, PERSONAL INJURY AND PROPERTY DAMAGE.

This document and other information from Parker Hannifin Corporation, its subsidiaries and authorized distributors provide product and/or system options for further investigation by users having technical expertise. It is important that you analyze all aspects of your application and review the information concerning the product or system in the current product catalog. Due to the variety of operating conditions and applications for these products or systems, the user, through its own analysis and testing, is solely responsible for making the final selection of the products and systems and assuring that all performance, safety and warning requirements of the application are met.

The products described herein, including without limitation, product features, specifications, designs, availability and pricing, are subject to change by Parker Hannifin Corporation and its subsidiaries at any time without notice.

**Offer of Sale**

The items described in this document are hereby offered for sale by Parker Hannifin Corporation, its subsidiaries or its authorized distributors. This offer and its acceptance are governed by the provisions stated in the "Offer of Sale".

© Copyright 2015, Parker Hannifin Corporation, All Rights Reserved

Definitions.....	3
Design Features .....	4 - 5
Introduction .....	5
Troubleshooting Guide .....	6
Troubleshooting Checklist.....	7
Tools and Material Required for Servicing.....	8
Bolt Torque .....	9
Exploded Assembly View .....	10-11
TF Service Parts List Chart.....	12-13
TG Service Parts List Chart.....	14-15
TH Service Parts List Chart.....	16-17
TL Service Parts List Chart.....	18
Disassembly & Inspection .....	19-26
Torqmotor™ Assembly.....	27-37
Rotor Set Component Assembly Procedure (One Piece Stator).....	37
Rotor Set Component Assembly Procedure (Two Piece Stator).....	38-39
Final Checks.....	40
Hydraulic Fluids, Filtration, Oil Temperature .....	40
Tips for Maintaining the System.....	41
Offer of Sale .....	Inside Back Cover

## Definitions

- NOTE:** A NOTE provides key information to make a procedure easier or quicker to complete.
- CAUTION:** A CAUTION refers to procedure that must be followed to avoid damaging the Torqmotor™ or other system components.
- WARNING:** A WARNING REFERS TO PROCEDURE THAT MUST BE FOLLOWED FOR THE SAFETY OF THE EQUIPMENT OPERATOR AND THE PERSON INSPECTING OR REPAIRING THE TORQMOTOR™.

## Disclaimer

This Service Manual has been prepared by Parker Hannifin for reference and use by mechanics who have been trained to repair and service hydraulic motors and systems on commercial and non-commercial equipment applications. Parker Hannifin has exercised reasonable care and diligence to present accurate, clear and complete information and instructions regarding the techniques and tools required for maintaining, repairing and servicing the complete line of Parker TF, TG, TH and TL Torqmotor™ Units. However, despite the care and effort taken in preparing this general Service Manual, Parker **makes no warranties** that (a) the Service Manual or any explanations, illustrations, information, techniques or tools described herein are either accurate, complete or correct as applied to a specific Torqmotor™ unit, or (b) any repairs or service of a particular Torqmotor™ unit will result in a properly functioning Torqmotor™ unit.

If inspection or testing reveals evidence of abnormal wear or damage to the Torqmotor™ unit or if you encounter circumstances not covered in the Manual, STOP – CONSULT THE EQUIPMENT MANUFACTURER’S SERVICE MANUAL AND WARRANTY. DO NOT TRY TO REPAIR OR SERVICE A TORQMOTOR™ UNIT WHICH HAS BEEN DAMAGED OR INCLUDES ANY PART THAT SHOWS EXCESSIVE WEAR UNLESS THE DAMAGED AND WORN PARTS ARE REPLACED WITH ORIGINAL PARKER REPLACEMENT AND SERVICE PARTS AND THE UNIT IS RESTORED TO PARKER SPECIFICATIONS FOR THE TORQMOTOR™ UNIT.

It is the responsibility of the mechanic performing the maintenance, repairs or service on a particular Torqmotor™ unit to (a) inspect the unit for abnormal wear and damage, (b) choose a repair procedure which will not endanger his/her safety, the safety of others, the equipment, or the safe operation of the Torqmotor™, and (c) fully inspect and test the Torqmotor™ unit and the hydraulic system to insure that the repair or service of the Torqmotor™ unit has been properly performed and that the Torqmotor™ and hydraulic system will function properly.

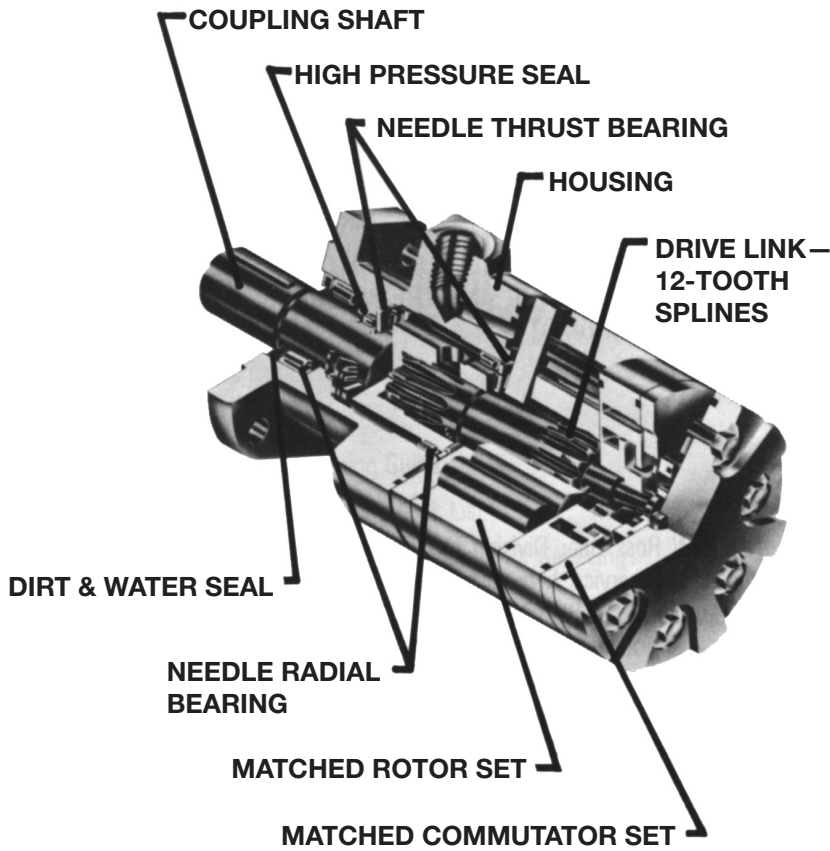

**Torqmotor™ TF Series features include:**

- Heavy-duty thrust and roller bearings for up to twice side-load capacity to the previous motor.
- Roller vanes to reduce friction and internal leakage, and to maintain efficiency.
- A patented orbiting commutation system for less wear and longer life.
- A patented 60:40 arrangement of internal and external spline members to transmit more torque with less weight.
- A unique high-pressure shaft seal that eliminates the need for case drains, check valves and extra plumbing.
- A unique manifold designed to improve operating efficiency.
- Up to 1000 lbs. (453.6 kg) end-thrust capacity in either direction.
- A design that is less sensitive to contamination than competitive motors.
- Up to 36 horsepower output.
- Greater durability because of superior lubrication and minimum drive spline wear.
- Superior low speed performance.
- Zero leak **commutation valve provides greater, more consistent volumetric efficiency.**

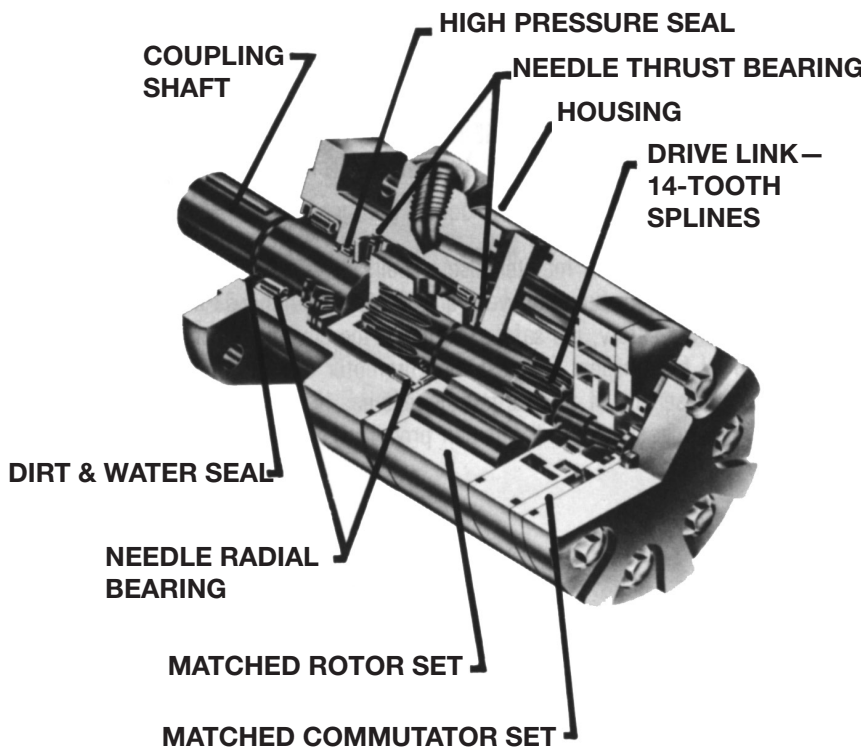

**Torqmotor™ TG/ TH/TL Series features include:**

- Roller vanes to reduce friction and internal leakage and to maintain efficiency.
- A patented orbiting commutation system for less wear and longer life.
- A patented 60:40 arrangement of internal and external spline members to transmit more torque with less weight.
- A unique high-pressure shaft seal that eliminates the need for case drains, check valves and extra plumbing.
- A manifold designed to improve operating efficiency.
- Heavy-duty thrust and roller bearings for up to twice the side-load capacity to the previous motor.
- Up to 1000 lbs. (453.6 kg) end-thrust capacity in either direction.
- A design that is less sensitive to contamination than competitive motors.
- Up to 49 horsepower output.
- Greater durability because of superior lubrication and minimum drive spline wear.
- Zero leak **commutation valve provides greater, more consistent volumetric efficiency.**

This service manual has one purpose: to guide you in maintaining, troubleshooting, and servicing the TF, TG, TH and TL Torqmotor™ (low-speed, high-torque hydraulic motor).

Material in this manual is organized so you can work on the Torqmotor™ and get results without wasting time or being confused. To get these results, you should read this entire manual before you begin any work on the Torqmotor™.

This manual also contains troubleshooting information and checklist. If you must service the Torqmotor™, the checklist will help you to determine where the problem may be.

The three-column format of the Disassembly and Inspection, and Assembly sections will make it easier for you to conduct major work on the Torqmotor™. Column 1 gives a brief key for each procedure. Column 2 explains in detail the procedure you should follow. Column 3 illustrates this procedure with photographs. Read all material carefully and pay special attention to the notes, cautions, and warnings.

A page with the Torqmotor™ exploded assembly view is provided several places in this manual. The component part names and item numbers assigned on this exploded assembly view correspond with names and item numbers (in parentheses) used in the disassembly and assembly procedures set forth in this manual. Service part list charts are also provided in this manual with the part names and exploded view item numbers cross referenced to Parker service part numbers.

Service parts are available through the Original Equipment Manufacturer or Parker approved TF, TG, TH and TL Torqmotor™ Distributors.

As you gain experience in servicing the Torqmotor™, you may find that some information in this manual could be clearer or more complete. If so, let us know about it. Do not try to second guess the manual. If you are stuck, contact us. Servicing the Torqmotor™ should be a safe and productive procedure, in order for the unit to deliver the reliable, long-life operation engineered into it.

NOTE: Before troubleshooting any system problem, check service literature published by the equipment and/or component manufacturers. Follow their instructions, if given, for checking any component other than the Torqmotor™ unit.

## Preparation

Make your troubleshooting easier by preparing as follows:

- work in a clean, well-lighted place;
- have proper tools and materials nearby;
- have an adequate supply of clean petroleum-based solvent.

**WARNING: SINCE SOLVENTS ARE FLAMMABLE, BE EXTREMELY CAREFUL WHEN USING ANY SOLVENT, EVEN A SMALL EXPLOSION OR FIRE COULD CAUSE INJURY OR DEATH.**

**WARNING: WEAR EYE PROTECTION AND BE SURE TO COMPLY WITH OSHA AND OTHER MAXIMUM AIR PRESSURE REQUIREMENTS.**

## Preliminary Checks

Hydraulic systems are often trouble-free. Hence, the problem an operator complains of could be caused by something other than the hydraulic components.

Thus, once you have determined that a problem exists, start with the easy-to-check items, such as:

- parts damaged from impact that were not properly repaired, or that should have been replaced; and
- improper replacement parts used in previous servicing
- mechanical linkage problems such as binding, broken, or loose parts or slipping belts

## Hydraulic Components

If you think the problem is caused by a hydraulic component, start by checking the easy-to-reach items.

Check all hoses and lines for cracks, hardening, or other signs of wear. Reroute any usable hoses that are kinked, severely bent, or that rest against hot engine parts. Look for leaks, especially at couplings and fittings. Replace any hoses or lines that don't meet system flow and pressure ratings.

Next, go to the reservoir and filter or filters. Check fluid level and look for air bubbles. Check the filter(s). A filter with a maximum 40 micron filtration is recommended for the Torqmotor™ system.

Visually check other components to see if they are loosely mounted, show signs of leaks, or other damage or wear.

Excessive heat in a hydraulic system can create problems that can easily be overlooked. Every system has its limitation for the maximum amount of temperature. After the temperature is attained and passed, the following can occur:

- oil seal leaks
- loss of efficiency such as speed and torque
- pump loss of efficiency
- pump failure
- hoses become hard and brittle
- hose failure

A normal temperature range means an efficient hydraulic system. Consult the manuals published by equipment and/or component manufacturers for maximum allowable temperature and hydraulic tests that may be necessary to run on the performance of the hydraulic components. The Torqmotor™ is not recommended for hydraulic systems with maximum temperatures above 200°F (93.3°C).

<b>Trouble</b>	<b>Cause</b>	<b>Remedy</b>
<b>Oil Leakage</b>	1. Hose fittings loose, worn or damaged.	Check & replace damaged fittings or “O” Rings. Torque to manufacturers specifications.
	2. Oil seal rings (4) deteriorated by excess heat.	Replace oil seal rings by disassembling Torqmotor™ unit.
	3. Special bolt (1, 1A, 1B or 1C) loose or its sealing area deteriorated by corrosion.	(a) Loosen then tighten single bolt to torque specification. (b) Replace bolt.
	4. Internal shaft seal (16) worn or damaged.	Replace seal. Disassembly of Torqmotor™ unit necessary.
	5. Worn coupling shaft (12) and internal seal (16).	Replace coupling shaft and seal by disassembling Torqmotor™ unit.
<b>Significant loss of speed under load</b>	1. Lack of sufficient oil supply	(a) Check for faulty relief valve and adjust or replace as required. (b) Check for and repair worn pump. (c) Check for and use correct oil for temperature of operation.
	2. High internal motor leakage	Replace worn rotor set by disassembling Torqmotor™ unit.
	3. Severely worn or damaged internal splines.	Replace rotor set, drive link and coupling shaft by disassembling Torqmotor™ unit.
	4. Excessive heat.	Locate excessive heat source (usually a restriction) in the system and correct the condition.
<b>Low mechanical efficiency or undue high pressure required to operate Torqmotor™ unit</b>	1. Line blockage	Locate blockage source and repair or replace.
	2. Internal interference	Disassemble Torqmotor™ unit, identify and remedy cause and repair, replacing parts as necessary.
	3. Lack of pumping pressure	Check for and repair worn pump.
	4. Excessive binding or loading in system external to Torqmotor™ unit.	Locate source and eliminate cause.

**CAUTION: If the hydraulic system fluid becomes overheated [in excess of 200°F (93.3°C)], seals in the system can shrink, harden or crack, thus losing their sealing ability.**

**Tools and Materials Required for Servicing TF, TG, TH and TL Series**

---

- Clean, petroleum-based solvent
- Emery paper
- Vise with soft jaws
- Air pressure source
- Arbor press
- Screw driver
- Masking tape
- Breaker bar
- Torque wrench-ft. lbs. (N m)
- Sockets: 1/2 or 9/16 inch thin wall, 1 inch
- Allen Sockets: 3/16, 3/8 inch
- Adjustable crescent wrench or hose fitting wrenches
- SAE 10W40 SE or SF oil
- Special bearing mandrel for TH Torqmotors (consult factory)
- Special bearing mandrel for TF, TG & TJ Torqmotors (SEE FIGURE 1)
- Feeler gage .005 inch (.13 mm)
- TH Torqmotors require blind hole bearing puller for a 1.575 inch dia. (40.0 mm) and 2.130 inch dia. (54.1 mm) bearings.
- TF, TG & TL Torqmotors require blind hole bearing puller for 1.400 inch dia. (35.6 mm) and 2.130 inch dia. (54.1 mm) bearings.
- Clean corrosion resistant grease. Part #406018 is included in each seal kit. Recommended grease is Parker Specification #045236 or Mobil Mobilith SHC® 460

**NOTE: The available service seal kits include the recommended grease as a grease pack #406018**

**CAUTION: Mixing greases that have different bases can be detrimental to bearing life.**



**CONVERSIONS**

INCHES	mm	INCHES	mm
.020	.51	1.060	26.92
.021	.53	1.295	32.89
.029	.74	1.297	32.94
.030	.76	1.396	35.46
.111	2.81	1.398	35.51
.119	3.02	1.620	41.15
.152	3.86	1.622	41.20
.160	4.06	1.983	50.37
.296	7.52	1.985	50.42
.304	7.72	2.120	53.85
.460	11.68	2.122	53.90
.470	11.94	2.233	56.72
.500	12.70	2.235	56.77
.585	14.86	2.483	63.07
.595	15.11	2.485	63.12
.660	16.76	2.500	63.5
.675	17.15	2.88	73.2
1.058	26.87		

**Torque Chart**

Part Name	Item Number	Torque
bolt 3/8 24 UNF 2A	1, 1A, 1B or 1C	45-55 ft. lbs. (60-76 N m)
bolt 5/8 18 UNF 2A	12D	140-180 ft. lbs. (190-244 N m)
nut 1-20 UNEF 2B	12B (TF, TG, TL)	300-400 ft. lbs. (407-542 N m)
nut 1-1/8 18 UNEF 2B	12B (TG, TH)	300-400 ft. lbs. (407-542 N m)

- TL press internal bearing .576 below face
- TH press internal bearing .120 below face

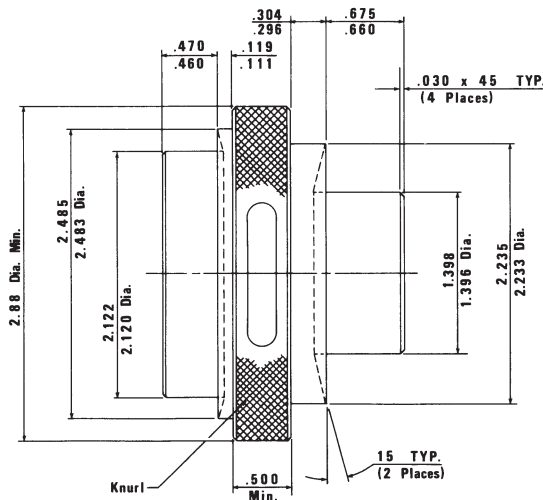

(Fabricate if considered necessary)  
 Figure 1 – TF & TG (see note)

**Typical Assembly**

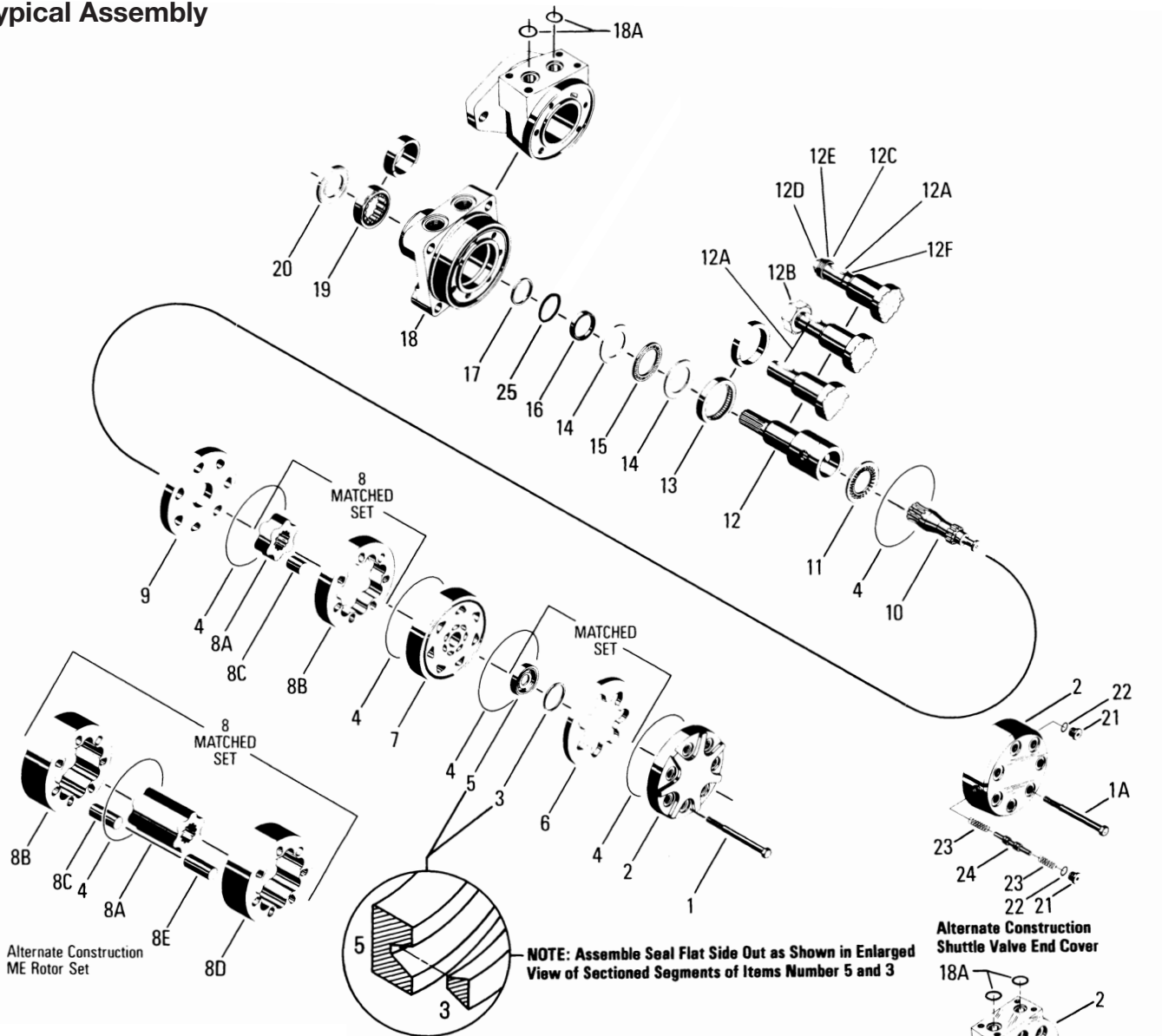

Item No.	Description
1.	Special Bolts (5, 6, or 7)
1a.	Special Bolts (7)
1b.	Special Bolts (7)
1c.	Special Bolts (7)
2.	End Cover
3.	Seal Ring-Commutator
4.	Seal Ring (5)
5.	Commutator
6.	Commutator Ring
7.	Manifold
8.	Rotor Set
8a.	Rotor
8b.	Stator or Stator Half
8c.	Vane (7)
8d.	Stator Half
8e.	Vane (7)

9.	Wear Plate
10.	Drive Link
11.	Thrust Bearing
12.	Coupling Shaft
12a.	Key
12b.	Nut
12c.	Washer
12d.	Bolt
12e.	Lockwasher
12f.	Retaining Ring
13.	Bearing, Inner
14.	Thrust Washer
15.	Thrust Bearing
16.	Seal
17.	Backup Ring

18.	Housing
18a.	O-Ring (2)
19.	Bearing, Outer
20.	Dirt & Water Seal
21.	Plug (2)
22.	O-Ring (2)
23.	Spring
24.	Valve (Shuttle or Relief)
25.	Backup Washer

= Items not sold separately. Sold as matched sets only.

**Typical Assembly**

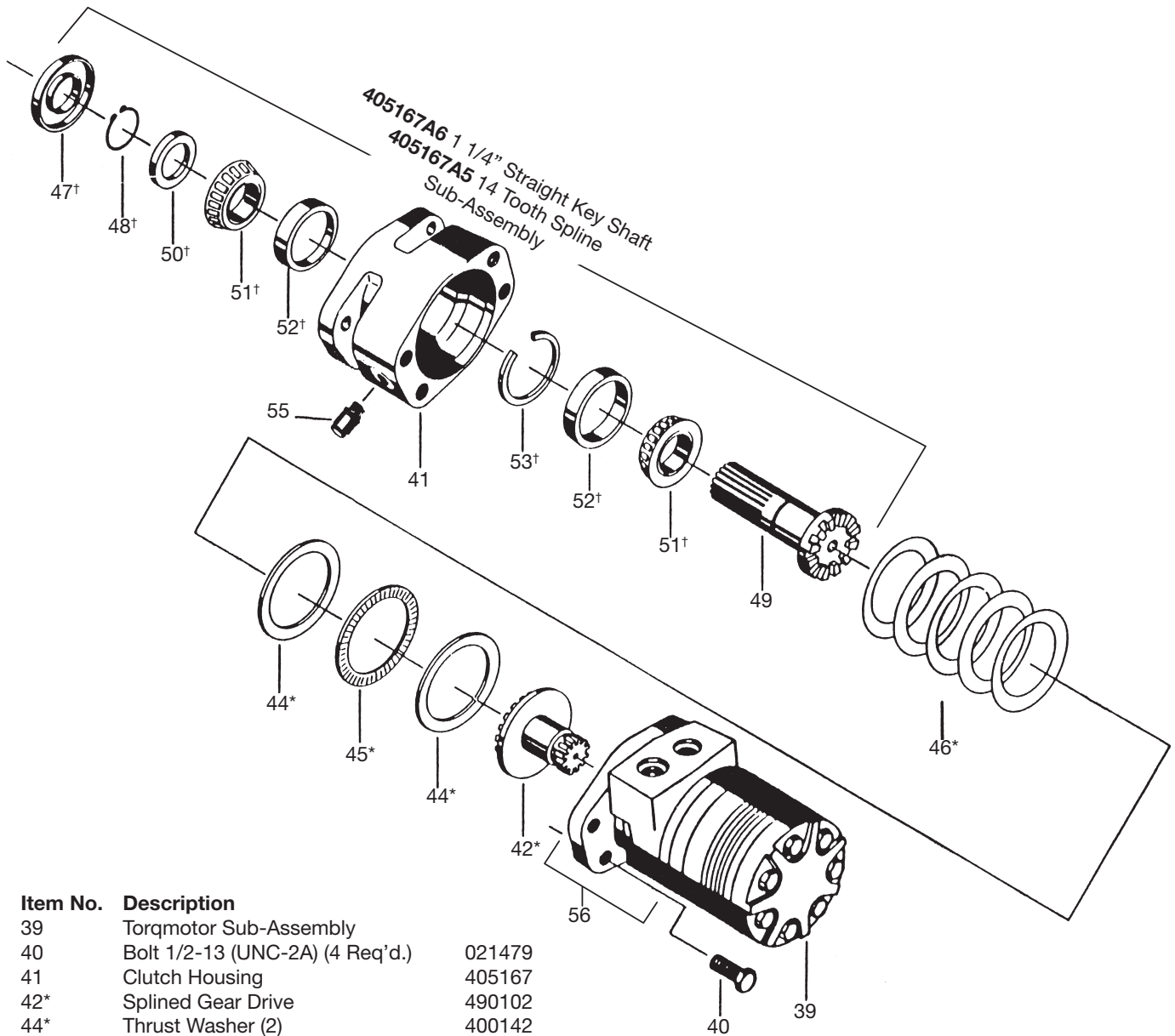

Item No.	Description	
39	Torqmotor Sub-Assembly	
40	Bolt 1/2-13 (UNC-2A) (4 Req'd.)	021479
41	Clutch Housing	405167
42*	Splined Gear Drive	490102
44*	Thrust Washer (2)	400142
45*	Thrust Bearing	073005
46*	Disc Spring (5)	028511
47†	Seal - Dirt and Water	478030
48†	Snap Ring	401623
49	Drive Shaft 14 Tooth Spline	093043
49	Straight Key Shaft 1 1/4"	093044
50†	Thrust Washer	400141
	Yellow	028027 .132 - .134
	White	028028 .138 - .140
	Green	028029 .144 - .146
	Blue	028030 .150 - .152
	Red	028031 .156 - .158
	Black	028032 .162 - .164
51†	Bearing and Cone Assembly (2)	067033
52†	Bearing Cup (2)	400140
53†	Retaining Ring	401623
55	Plug	036024
56	Housing	ME012013A1

NOTE: Apply .06 in. (1.5 mm) Bead of Loctite #51514 Around Full Circumference of Pilot

\* Items sold separately: not included in Seal Kit

† °SK000039 for Clutch Assembly only

SK000092 Seal Kit for Hydraulic Motor only Item #39.

Clutch Motor applies to TF Series only (Not available in 22, 25, 29 cu in.)

SHC Oil 90 WT 45± 5CC

**Chart Use Example:**

TF0080AS010AAAB Torqmotor™ includes part numbers listed to the right of TF (SERIES), 0080 (DISP.), AS (MOUNTING/PORTING), 01(SHAFT), 0 (ROTATION), and AAAA (OPTION) shown in the left hand column of the chart.

**Caution:**

The charted component service information is for the Torqmotors listed only. Refer to the original equipment manufacturer of the equipment using the Torqmotor for assembly numbers not listed below.

EXPLODED VIEW												
SERIES	ITEM #	5 & 6	7	9	11	13	14	15	17	19	20	25
	DESCRIPTION	COMMUTATOR ASSEMBLY	MANIFOLD (SEE NOTE)	WEAR PLATE	THRUST BEARING	INNER BEARING	THRUST WASHER(2)	THRUST BEARING	BACKUP WASHER	OUTER BEARING	DIRT & WATER SEAL	BACKUP WASHER
TF-	Service Part #	ME018000A1	ME015000	477342	068024	071019	400136	069017	028515	068027	478035	029118

EXPLODED VIEW <sup>2</sup> (SELECT ITEM # BOLT PER OPTION GROUP)											
DISPLACEMENT GROUP	ITEM #	1 OR 1A OR 1B OR 1C				8A		8B		10	
	DISPLACEMENT (in <sup>3</sup> /rev)	ROTOR THICKNESS				ROTOR SET	ROTOR SET	DRIVE LINK	"L DIM"		
		BOLT (7)	BOLT (7)	BOLT (7)	BOLT (7)				12 TOOTH	14 TOOTH	
0080-	4.9	021326	021340	021273	021413	<b>.4393</b>	MB057003	MB057005	MB063000	<b>4.262"</b>	
0100-	6.1	021326	021340	021273	021413	<b>.4393</b>	MB067003	MB067005	MB063000	<b>4.262"</b>	
0130-	7.8	021271	021386	021273	021279	<b>.5643</b>	MB087003	MB087005	MB083000	<b>4.388"</b>	
0140-	8.6	021390	021273	021273	021379	<b>.6268</b>	MB097003	MB097005	MB093000	<b>4.451"</b>	
0170-	10.3	021376	021387	021387	021392	<b>.7518</b>	MB107003	MB107005	MB103000	<b>4.577"</b>	
0195-	12.0	021352	021379	021379	021291	<b>.8768</b>	MB127003	MB127005	MB123000	<b>4.703"</b>	
0240-	14.5	021272	021291	021291	021412	<b>1.0643</b>	MB157003	MB157005	MB153000	<b>4.892"</b>	
0280-	17.1	021340	021392	021392	021385	<b>1.2518</b>	MB187003	MB187005	MB183000	<b>5.081"</b>	
0360-†	22.2	021387	021378	021378	021415	<b>1.5018</b>	ME237003	ME237007	ME233000		<b>5.458"</b>
0365-	22.2	021387	021378	021378	021415	<b>1.6268</b>	MB237003	MB237005	MB233000	<b>5.458"</b>	
0405-†	24.7	021379	021366	021415	021374	<b>1.7923</b>	ME247003	ME247007	ME243000		<b>5.604"</b>
0475-†	29.1	021392	021394	021394	021393	<b>2.1268</b>	ME297003	ME297007	ME293000		<b>5.947"</b>

† (Not available in clutch motor)

FRONT PORTING	EXPLODED VIEW		SPEED SENSOR				
	Mounting Code	ITEM #	2	18	18	18	
	Porting Code	DESCRIPTION	END COVER	SERVICE HOUSING ASS'Y	SERVICE HOUSING ASS'Y	SENSOR	
	MS-	Standard (4 Bolt)		ME016000	ME012001A1	ME012301A1	455063
	US-	Wheel Mt. (4 Bolt)	7/8" O-Ring	ME016000	ME012002A1	ME012302A1	455063
	AS-	SAE A (2 Bolt)	7/8" O-Ring	ME016000	ME012006A1	ME012306A1	455063
	HS-	Whl. (US) w/Machined Pilot Nose	7/8" O-Ring	ME016000	ME012008A1		
	LS-	Whl. w/Brake Mt. (4 Bolt)	7/8" O-Ring	ME016000	ME012009A1		
	BS-	SAE B (2 Bolt)	7/8" O-Ring	ME016000	ME012019A1	ME012319A1	455063
	<b>GS-</b>	<b>Clutch Motor</b>	<b>7/8" O-Ring</b>	<b>ME016000</b>	<b>ME012013A1</b>		
	AM-	SAE A (2 Bolt)	Manifold	ME016000	ME012028A1	ME012328A1	455063
	MM-	Standard (4 Bolt)	Manifold	ME016000	ME012018A1		
	AT-	SAE A (2 Bolt)	1/2" BSPF	ME016000	ME012027A1		
	MT-	Standard (4 Bolt)	1/2" BSPF	ME016000	ME012010A1	ME012310A1	455063

HOUSING GROUP	EXPLODED VIEW		SPEED SENSOR				
	ITEM #	1, 1A, 1B, 1C	2	18	18	18	
	DESCRIPTION	PORTING	BOLT	END COVER	SERVICE HOUSING ASS'Y	SERVICE HOUSING ASS'Y	SENSOR
	MA-	Standard (4 Bolt)	Rear Port (7/8" O-Ring; Axial)	Item #1B	ME016009	ME012004A1	
	UA-	Wheel Mt. (4 Bolt)	Rear Port (7/8" O-Ring; Axial)	Item #1B	ME016009	ME012005A1	
	AA-	SAE A (2 Bolt)	Rear Port (7/8" O-Ring; Axial)	Item #1B	ME016009	ME012007A1	ME012307A1 455063
	WA-	Wheel, Optional (4 Bolt)	Rear Port (7/8" O-Ring; Axial)	Item #1B	ME016009	ME012011A1	
	VA-	SAE A (4 Bolt)	Rear Port (7/8" O-Ring; Axial)	Item #1B	ME016009	ME012049A1	
	MB-	Standard (4 Bolt)	Rear Port (7/8" O-Ring; Radial)	Item #1B	ME016002	ME012004A1	
	UB-	Wheel Mt. (4 Bolt)	Rear Port (7/8" O-Ring; Radial)	Item #1B	ME016002	ME012005A1	
	AB-	SAE A (2 Bolt)	Rear Port (7/8" O-Ring; Radial)	Item #1B	ME016002	ME012007A1	ME012307A1 455063
	WB-	Wheel, Optional (4 Bolt)	Rear Port (7/8" O-Ring; Radial)	Item #1B	ME016002	ME012011A1	
	VB-	SAE A (4 Bolt)	Rear Port (7/8" O-Ring; Radial)	Item #1B	ME016002	ME012049A1	
	ME-	Standard (4 Bolt)	Rear Port (Manifold; Radial)	Item #1B	ME016001J1	ME012004A1	
	UE-	Wheel Mt. (4 Bolt)	Rear Port (Manifold; Radial)	Item #1B	ME016001J1	ME012005A1	
	AE-	SAE A (2 Bolt)	Rear Port (Manifold; Radial)	Item #1B	ME016001J1	ME012007A1	ME012307A1 455063
	WE-	Wheel, Optional (4 Bolt)	Rear Port (Manifold; Radial)	Item #1B	ME016001J1	ME012011A1	
	VE-	SAE A (4 Bolt)	Rear Port (Manifold; Radial)	Item #1B	ME016001J1	ME012049A1	



EXPLODED VIEW ITEM #	DESCRIPTION	SPEED SENSOR		CLUTCH MOTOR						
		12	12	12	12A	12B	12C	12D	12E	12F
		COUPLING SHAFT	COUPLING SHAFT	COUPLING SHAFT	KEY	NUT	WASHER	5/8-18 BOLT	LOCK WASHER	RETAINING RING
01-	Long 6B Snapwire Groove	MB019001	MB019301							
02-	Long Woodruff, 1/4" Tap Snapwire Groove	MB019002	MB019302		038015*					
03-	1.25" Straight Keyed 5/8-18 Int. Thd.	MB019003	MB019303	<b>093044</b>	039028***		028413	021482	028992	401333
04-	10B Spline	MB019004	MB019304							
05-	14 Tooth Spline 5/8-18 Int. Thd.	MB019005	MB019305	<b>093043</b>			028413	021482	028992	
06-	19 Tooth Spline	MB019006								
07-	15 Tooth Spline	MB019007	MB019307							
08-	1.25" Tapered Shaft	MB019000	MB019300		038016**	025126				
17-	19 Tooth Spline (16/32)	MB019011								
22-	25mm Str. w/7mm Key	MB109009	MB019209							
26-	25mm Str. w/8mm Key	MB019017	MB019317							
28-	13 Tooth Spline (16/32)	MB019023	MB019323							
58-	1.25" Str. Nitrotec C	MB019040								

EXPLODED VIEW ITEM #	DESCRIPTION	SPEED SENSOR		
		12	12	12
		COUPLING SHAFT	COUPLING SHAFT	SENSOR
01-	Long 6B Snapwire Groove	ME019001	ME019301	455063
02-	Long Woodruff, 1/4" Tap Snapwire Groove	ME019002	ME019302	455063
03-	1.25" Straight Keyed 5/8-18 Int. Thd.	ME019003	ME019303	455063
04-	10B Spline	ME019004	ME019304	
05-	14 Tooth Spline 5/8-18 Int. Thd.	ME019005	ME019305	455063
06-	19 Tooth Spline	ME019006		
07-	15 Tooth Spline	ME019007		
08-	1.25" Tapered Shaft	ME019000	ME019300	455063
19-	1.38" Tapered 1.125-18 Thd.	ME019010		
20-	1.38" Straight Key 5/8 Tap	ME019011	ME019311	

EXPLODED VIEW ITEM #	DESCRIPTION	† (Not available in clutch motor)									
		2 <sup>1</sup> , 1A, 1B, 1C	2	3	4	16	6 <sup>21</sup> & 22	4,6 <sup>22</sup>	6 <sup>23</sup>	6 <sup>24</sup>	12B
		BOLT (7)	END COVER	COMMUTATOR SEAL	INNERPLUG & O-RING SEAL	ASSEMBLY	O-RINGS	SPRING (2)	VALVE	CASTLE NUT	SPEED SENSOR
AAAA	Black Paint	Item #1		032435	032819	032817					
AAAC	Corrosion Resistant Paint	Item #1		032435	032819	032817					
AAAF	Castle Nut Replacing Patch Lock Nut	Item #1		032435	032819	032817				025113	
AAAG	Fluorocarbon Seals, Black Paint	Item #1		032435	032820	032818					
AAAH	Fluorocarbon Seals, No Paint	Item #1		032435	032820	032818					
AAAT	Bidirectional Shuttle Valve 11:00	Item #1A	6 <sup>ME016003A1</sup>	032435	032819	032817	036297	032791	401642	415569	
AAAU	Bidirectional Shuttle Valve 11:00 & Castle Nut	Item #1A	6 <sup>ME016003A1</sup>	032435	032819	032817	036297	032791	401642	415569	
BBBA	1000 PSI Cross Port Relief Endcover, Black Paint	Item #1C	6 <sup>ME016004A1</sup>	032435	032819	032817	411063A1	032424		410009-40 (2), 1000 PSI	
BBBG	1500 PSI Cross Port Relief Endcover, Black Paint	Item #1C	ME016004A5	032435	032819	032817	411063A1	032424		410009-07 (2), 1500 PSI	
BBBB	2000 PSI Cross Port Relief Endcover, Black Paint	Item #1C	6 <sup>ME016004A2</sup>	032435	032819	032817	411063A1	032424		410009-09 (2), 2000 PSI	
BBCG	2500 PSI Int. Bidirectional Relief Endcover, No Paint	Item #1C	ME016004A6	032435	032819	032817	411063A1	032424		410009-11 (2), 2500 PSI	
BBCX	2500 PSI Int. Bidirectional Relief Endcover, No Nut, Black Paint	Item #1C	ME016004A6	032435	032819	032817	411063A1	032424		410009-11 (2), 2500 PSI	
BBCW	3000 PSI Int. Bidirectional Relief Endcover, No Nut, No Paint	Item #1C	ME016004A3	032435	032819	032817	411063A1	032424		410009-13 (2), 3000 PSI	
BBBC	3000 PSI Cross Port Relief Endcover, Black Paint	Item #1C	6 <sup>ME016004A3</sup>	032435	032819	032817	411063A1	032424		410009-13 (2), 3000 PSI	
BBBD	4000 PSI Cross Port Relief Endcover, Black Paint	Item #1C	6 <sup>ME016004A4</sup>	032435	032819	032817	411063A1	032424		410009-16 (2), 4000 PSI	
DDDA	Clutch Motor	Item #1	ME016000	032435	032819	032817					
FSAA	Speed Sensor Option	Item #1	ME016000	032435	032819	032817				455063	

For reverse timed manifold, use ME015001.

<sup>1</sup> Service housing ass'y ITEM #18 with part number suffix-A1 includes ITEM #13, #14 two req'd, #15 and #19.

<sup>2</sup> Select the required bolt number in designated "DISPLACEMENT GROUP" under bolt ITEM #1, 1A, 1B or 1C shown in designated "OPTION GROUP."

<sup>3</sup> 1-20 UNEF slotted nut #025113 is required on 1-1/4" tapered shaft if the designated "OPTION GROUP" is AAAF, AAAN, or AAUA.

<sup>4</sup> ITEM #22 is part of plug & o-ring ass'y's but can be serviced separately.

<sup>5</sup> Service endcover ME016001J1 includes two #032790 o-rings, ITEM 18A on the exploded ass'y view that can also be serviced separately.

<sup>6</sup> End cover assembly item #2 also includes item #21, #22, #24 and if required item #23. All but item #21 can be serviced separately.

<sup>7</sup> ME018001A1 commutator ass'y. is required if the designated "OPTION GROUP" is AAAM, AAAN, or AAAP.

<sup>8</sup> Order (2) #032790 seals for parts when ordering manifold-style porting. Standard seal kit #SK000092 includes six #032819 seal rings, #032435 commutator seal, #032817 inner seal, #028515 and #029118 back washers, #478035 dirt & water, #406018 grease pack, bulletin #050016. Special seal kit #SK000093 for units that use fire retardant fluids includes six #032820 seal rings, #032435 commutator seal, #032818 inner seal, #028515 and #029118 back up washers, #478035 dirt & water seal, #406018 grease pack, bulletin #050016. High Temp commutator seal AADJ #032861. High temperature seal black in color. \* Standard seal kit #SK000092 for motor only. If repairing clutch, need #SK000039. Kit includes two #067033 bearing and cone assemblies, two #400140 bearing cups, one #400141 thrust washer, one #401622 snap ring, one #401632 retaining ring, and one #478030 dirt and water seal. #SK000099 High Temp commutator seal kit, #032861 Vespel seal, #032817 inner seal, #028515 and #029118 back up washers, #478035 dirt & water seal, #032819 six seal rings, #406018 grease pack, bulletin #050016.





**TG Service Parts List Chart**

**Torqmotor™ Service Procedure  
TF, TG, TH and TL Series**

**Chart Use Example:**

TG0140AS010AAAB Torqmotor™ includes part numbers listed to the right of TG (SERIES), 0140 (DISP.), AS (MOUNTING/PORTING), 01(SHAFT), 0 (ROTATION), and AAAB (OPTION) shown in the left hand column of the chart.

**Caution:**

The charted component service information is for the Torqmotors listed only. Refer to the original equipment manufacturer of the equipment using the Torqmotor for assembly numbers not listed below.

EXPLODED VIEW												
SERIES	ITEM #	<sup>7</sup> 5 & 6	7	9	11	<sup>13</sup>	<sup>14</sup>	<sup>15</sup>	17	<sup>19</sup>	20	25
	DESCRIPTION	COMMUTATOR ASSEMBLY	MANIFOLD (see note)	WEAR PLATE	THRUST BEARING	INNER BEARING	THRUST WASHER(2)	THRUST BEARING	BACKUP WASHER	OUTER BEARING	DIRT & WATER SEAL	BACKUP WASHER
TG-Service Part #	ME018000A1	ME015000	477342	068024	071031	400136	069017	028515	068027	478035	029118	

EXPLODED VIEW <sup>2</sup> (SELECT ITEM # BOLT PER OPTION GROUP)											
DISPLACEMENT GROUP	ITEM #	1	or	1A	or	1B	or	1C	8A	8B	10
	DISPLACEMENT (in <sup>3</sup> /rev)	BOLT (7)	BOLT (7)	BOLT (7)	BOLT (7)	ROTOR THICKNESS	ROTOR SET	FREE RUNNING ROTOR SET	DRIVE LINK	DRIVE LINK "L DIM"	
0140-	8.6	021390	021273	021273	021379	<b>.6286</b>	ME097003	ME097007	ME093000	<b>4.4385</b>	
0170-	10.3	021376	021387	021387	021392	<b>.7518</b>	ME107003	ME107007	ME103000	<b>4.5650</b>	
0195-	12.0	021352	021379	021379	021291	<b>.8768</b>	ME127003	ME127007	ME123000	<b>4.6905</b>	
0240-	14.5	021272	021291	021291	021412	<b>1.0643</b>	ME157003	ME157007	ME153000	<b>4.8795</b>	
0280-	17.1	021340	021392	021392	021385	<b>1.2518</b>	ME187003	ME187007	ME183000	<b>5.0685</b>	
0310-	18.9	021340		021385		<b>1.3738</b>	ME197003	ME197007	ME193000	<b>5.1935</b>	
0335-	20.6	021273	021385	021385	021366	<b>1.5018</b>	ME217003	ME217007	ME213000	<b>5.3195</b>	
0405-	24.7	021379	021366	021415	021374	<b>1.7923</b>	ME247003	ME247007	ME243000	<b>5.6045</b>	
0475-	29.1	021392	021394	021394	021393	<b>2.1268</b>	ME297003	ME297007	ME293000	<b>5.9475</b>	
0530-	32.3	021385	021393	021393	021395	<b>2.3768</b>	ME337003	ME337007	ME333000	<b>6.1985</b>	
0625-	38.0	021366	021329	021329	021458	<b>2.7536</b>	ME377003	N/A	ME373000	<b>6.5745</b>	
0785-	48.0	021395	021388	021388	021416	<b>3.5036</b>	ME487003	N/A	ME483000	<b>7.3285</b>	
0960-	58.5	021396	021389	021389	021399	<b>4.2536</b>	ME587003	N/A	ME583000	<b>8.0815</b>	

FRONT PORTING	EXPLODED VIEW				SPEED SENSOR		
	Mounting Code	Porting Code	ITEM #	<sup>18</sup>	<sup>18A</sup>	18	18
	DESCRIPTION	SERVICE					
	MOUNTING	<sup>8</sup> PORTING	HOUSING ASS'Y	O-RING (2)	SERVICE HOUSING ASS'Y	SENSOR	
MS-	Standard (4 Bolt)	7/8" O-Ring	ME012001A3		ME012301A3	455063	
US-	Wheel Mt. (4 Bolt)	7/8" O-Ring	ME012002A3		ME012302A3	455063	
AS-	SAE A (2 Bolt)	7/8" O-Ring	ME012006A3		ME012306A3	455063	
BS-	SAE B (2 Bolt)	7/8" O-Ring	ME012019A3		ME012319A3	455063	
HS-	Wheel (US) with Machined Pilot Nose	7/8" O-Ring	ME012008A3				
AM-	SAE A (2 Bolt)	Manifold	ME012028A3	032790	ME012328A3	455063	
MM-	Standard (4 Bolt)	Manifold	ME012018A3	032790			
AT-	SAE A (2 Bolt)	1/2" BSPF	ME012027A3				
MT-	Standard (4 Bolt)	1/2" BSPF	ME012010A3		ME012310A3	455063	

HOUSING GROUP	EXPLODED VIEW				SPEED SENSOR			
	Mounting Code	Porting Code	ITEM #	1, 1A, 1B, 1C	2	<sup>18</sup>	18	18
	DESCRIPTION	SERVICE						
	MOUNTING	<sup>8</sup> PORTING	BOLT	END COVER	SERVICE HOUSING ASS'Y	SERVICE HOUSING ASS'Y	SENSOR	
MA-	Standard (4 Bolt)	Rear Port (7/8" O-Ring; Axial)	Item #1B	ME016009	ME012004A3			
UA-	Wheel Mt. (4 Bolt)	Rear Port (7/8" O-Ring; Axial)	Item #1B	ME016009	ME012005A3			
AA-	SAE A (2 Bolt)	Rear Port (7/8" O-Ring; Axial)	Item #1B	ME016009	ME012007A3	ME012307A3	455063	
WA-	Wheel, Optional (4 Bolt)	Rear Port (7/8" O-Ring; Axial)	Item #1B	ME016009	ME012011A3			
VA-	SAE A (4 Bolt)	Rear Port (7/8" O-Ring; Axial)	Item #1B	ME016009	ME012049A3			
MB-	Standard (4 Bolt)	Rear Port (7/8" O-Ring; Radial)	Item #1B	ME016002	ME012004A3			
UB-	Wheel Mt. (4 Bolt)	Rear Port (7/8" O-Ring; Radial)	Item #1B	ME016002	ME012005A3			
AB-	SAE A (2 Bolt)	Rear Port (7/8" O-Ring; Radial)	Item #1B	ME016002	ME012007A3	ME012307A3	455063	
WB-	Wheel, Optional (4 Bolt)	Rear Port (7/8" O-Ring; Radial)	Item #1B	ME016002	ME012011A3			
VB-	SAE A (4 Bolt)	Rear Port (7/8" O-Ring; Radial)	Item #1B	ME016002	ME012049A3			
ME-	Standard (4 Bolt)	Rear Port (Manifold; Radial)	Item #1B	ME016001J1	ME012004A3			
UE-	Wheel Mt. (4 Bolt)	Rear Port (Manifold; Radial)	Item #1B	ME016001J1	ME012005A3			
AE-	SAE A (2 Bolt)	Rear Port (Manifold; Radial)	Item #1B	ME016001J1	ME012007A3	ME012307A3	455063	
WE-	Wheel, Optional (4 Bolt)	Rear Port (Manifold; Radial)	Item #1B	ME016001J1	ME012011A3			
VE-	SAE A (4 Bolt)	Rear Port (Manifold; Radial)	Item #1B	ME016001J1	ME012049A3			



	EXPLODED VIEW		SPEED SENSOR						
	ITEM #	12	12	12A	12B	12C	12D	12E	12F
	DESCRIPTION	COUPLING SHAFT	COUPLING SHAFT	KEY	NUT	WASHER	5/8-18 BOLT	LOCK WASHER	RETAINING RING
COUPLING SHAFT GROUP	01-	Long 6B Snapwire Groove	ME019001	ME019301					
	02-	Long Woodruff, 1/4" Tap Snapwire Groove	ME019002	ME019302	038015*				
	03-	1.25" Straight Keyed 5/8-18 Int. Thd.	ME019003	ME019303	039028***		028413	021482	028992 401333
	04-	10B Spline	ME019004	ME019304					
	05-	14 Tooth Spline 5/8-18 Int. Thd.	ME019005	ME019305			028413	021482	028992
	06-	19 Tooth Spline	ME019006						
	07-	15 Tooth Spline	ME019007						
	08-	1.25" Tapered Shaft	ME019000	ME019300	038016**	3025126			
	19-	1.38" Tapered 1.125-18 Thd.	ME019010		038016**	7025139			
	20-	1.38" Straight Key 5/8 Tap	ME019011	ME019311	039028		028518	021482	028992 401658

\* (1/4 x 1)  
\*\* (5/16 x 1)  
\*\*\* (0.132sq. x 1.437)

	EXPLODED VIEW										
	ITEM #	2 <sup>1</sup> , 1A, 1B, 1C	2	3	4	16	6 <sup>2</sup> 1 & 22	4 <sup>6</sup> 22	6 <sup>2</sup> 3	6 <sup>2</sup> 4	SPEED SENSOR
	DESCRIPTION	BOLT (7)	END COVER	COMMUTATOR SEAL	INNER RING (5)	INNER SEAL	PLUG & O-RING ASSEMBLY	O-RING	SPRING (2)	VALVE	
OPTION GROUP	AAAA	Black Paint	Item #1	ME016000	032435	032819	032817				
	AAAC	Corrosion Resistant Paint	Item #1	ME016000	032435	032819	032817				
	AAAF	Castle Nut Replacing Patch Lock Nut	Item #1	ME016000	032435	032819	032817				
	AAAG	Fluorocarbon Seals	Item #1	ME016000	032435	032820	032818				
	AAAT	Bidirectional Shuttle Valve Endcover 11:00	Item #1A	6ME016003A1	032435	032819	032817	036297	032791	401642	415569
	AAAU	Bidirectional Shuttle Valve Endcover 11:00 & Castle Nut	Item #1A	6ME016003A1	032435	032819	032817	036297	032791	401642	415569
	BBBA	1000 PSI Cross Port Relief Endcover	Item #1C	6ME016004A1	032435	032819	032817	411063A1	032424		410009-40, 1000 PSI
	BBBG	1500 PSI Cross Port Relief Endcover	Item #1C	ME016004A5	032435	032819	032817	411063A1	032424		410009-07, 1500 PSI
	BBBB	2000 PSI Cross Port Relief Endcover	Item #1C	6ME016004A2	032435	032819	032817	411063A1	032424		410009-09, 2000 PSI
	BBCG	2500 PSI Cross Port Relief Endcover	Item #1C	ME016004A6	032435	032819	032817	411063A1	032424		410009-11, 2500 PSI
	BBBC	3000 PSI Cross Port Relief Endcover	Item #1C	6ME016004A3	032435	032819	032817	411063A1	032424		410009-13, 3000 PSI
	BBBD	4000 PSI Cross Port Relief Endcover	Item #1C	6ME01604A4	032435	032819	032817	411063A1	032424		410009-16, 4000 PSI
	FSAA	Speed Sensor Option	Item #1	ME016000	032435	032819	032817				455063

For reverse timed manifold, use ME015001.

<sup>1</sup> Service housing ass'y ITEM #18 with part number suffix-A3 includes ITEM #13, #14 two req'd, #15 and #19.

<sup>2</sup> Select the required bolt number in designated "DISPLACEMENT GROUP" under bolt ITEM #1, 1A, 1B or 1C shown in designated "OPTION GROUP."

<sup>3</sup> 1-20 UNEF slotted nut #025113 is required on 1-1/4" tapered shaft if the designated "OPTION GROUP" is AAAF, AAAN, or AAAU.

<sup>4</sup> ITEM #22 is part of plug & o-ring ass'y's but can be serviced separately.

<sup>5</sup> Service end cover ME016001J1 includes two #032790 o-rings, ITEM 18A on the exploded ass'y view that can also be serviced separately.

<sup>6</sup> End cover assembly item #2 also includes item #21, #22, #24 and if required item #23. All but item #21 can be serviced separately.

<sup>7</sup> ME018001A1 commutator ass'y. is required if the designated "OPTION GROUP" is AAAM, AAAN, or AAAP.

<sup>8</sup> Order (2) #032790 seals for parts when ordering manifold-style porting.

Standard seal kit #SK000092 includes six #032819 seal rings, #032435 commutator seal, #032817 inner seal, #028515 and #029118 back washers, #478035 dirt & water seal, #406018 grease pack, bulletin #050016.

Special seal kit #SK000093 for units that use fire retardant fluids includes six #032820 seal rings, #032435 commutator seal, #032818 inner seal, #028515 and #029118 back up washers, #478035 dirt & water seal, #406018 grease pack, bulletin #050016.

High Temp commutator seal AAAJ #032861. High temp seal black in color.

(08) 1-1/4 Shaft Castle Nut 1-20 #025139

(08) 1-1/4 Shaft Castle Nut 1-20 #025113

(19) 1-3/8 Shaft Castle Nut 1-1/8-18 #025139

Shaft nuts are zinc dichromate.

**TH Service Parts List Chart**

**Torqmotor™ Service Procedure  
TF, TG, TH and TL Series**

**Chart Use Example:**

TH0140MS310AAAB Torqmotor™ includes part numbers listed to the right of TH (SERIES), 0140 (DISP), M (MOUNTING), S (PORTING), 31 (SHAFT), 0 (ROTATION), and AAAB (OPTION) shown in the left hand column of the chart.

**Caution:**

The charted component service information is for the Torqmotors listed only. Refer to the original equipment manufacturer of the equipment using the Torqmotor for assembly numbers not listed below.

EXPLODED VIEW												
SERIES	ITEM #	<sup>8</sup> 5 & 6	7	9	11	<sup>1</sup> 13	<sup>1</sup> 14	<sup>1</sup> 15	17	<sup>1</sup> 19	20	25
	DESCRIPTION	COMMUTATOR ASSEMBLY	MANIFOLD (SEE NOTE)	WEAR PLATE	THRUST BEARING	INNER BEARING	THRUST WASHER(2)	THRUST BEARING	BACKUP WASHER	OUTER BEARING	DIRT & WATER SEAL	BACKUP WASHER
TH-Service Part #	ME018000A1	ME015000	477342	068024	071031	069010 (2)	069022	028537	069034	478063	028538	

EXPLODED VIEW <sup>2</sup> (SELECT ITEM # BOLT PER OPTION GROUP)											
DISPLACEMENT GROUP	ITEM #	<sup>1</sup> OR 1A OR 1B OR 1C				8A	8B	10			
	DISPLACEMENT (in <sup>3</sup> /rev)	BOLT (7)	BOLT (7)	BOLT (7)	BOLT (7)	ROTOR THICKNESS	ROTOR SET	FREE RUNNING ROTOR SET	DRIVE LINK	DRIVE LINK "L DIM"	
	0140-	8.6	021390	021273	021273	021379	.6286	ME097003	ME097007	ME093000	4.4385
0170-	10.3	021376	021387	021387	021392	.7518	ME107003	ME107007	ME103000	4.5650	
0195-	12.0	021352	021379	021379	021291	.8768	ME127003	ME127007	ME123000	4.6905	
0240-	14.5	021272	021291	021291	021412	1.0643	ME157003	ME157007	ME153000	4.8795	
0280-	17.1	021340	021392	021392	021385	1.2518	ME187003	ME187007	ME183000	5.0685	
0335-	20.6	021273	021385	021385	021366	1.5018	ME217003	ME217007	ME213000	5.3195	
0405-	24.7	021379	021366	021415	021374	1.7923	ME247003	ME247007	ME243000	5.6045	
0475-	29.1	021392	021394	021394	021393	2.1268	ME297003	ME297007	ME293000	5.9475	
0530-	32.3	021385	021393	021393	021395	2.3768	ME337003	ME337007	ME333000	6.1985	
0625-	38.0	021366	021329	021329	021458	2.7536	ME377003	N/A	ME373000	6.5745	
0785-	48.0	021395	021388	021388	021416	3.5036	ME487003	N/A	ME483000	7.3285	
0960-	58.5	021396	021389	021389	021399	4.2536	ME587003	N/A	ME583000	8.0815	

FRONT PORTING	Mounting Code Porting Code	EXPLODED VIEW			<sup>1</sup> 18
		ITEM #	DESCRIPTION	SERVICE HOUSING ASS'Y	
			MOUNTING	PORTING	
MS-			SAE A (4 Bolt)	7/8" O-Ring	MJ012002A1
US-			Wheel Mt. (4 Bolt)	7/8" O-Ring	MJ012001A1
MM-			Standard Mt. (4 Bolt)	Manifold	MJ012014A1

HOUSING GROUP	Mounting Code Porting Code	EXPLODED VIEW					
		ITEM #	1, 1A, 1B, 1C	2	<sup>1</sup> 18		
			MOUNTING	PORTING	BOLT	END COVER	SERVICE HOUSING ASS'Y
MA-			Standard Mount (4 Bolt)	Rear Port (7/8" O-Ring; Axial)	Item #1B	ME016009	MJ012004A1
UA-			Wheel Mt. (4 Bolt)	Rear Port (7/8" O-Ring; Axial)	Item #1B	ME016009	MJ012003A1
MB-			Standard Mount (4 Bolt)	Rear Port (7/8" O-Ring; Radial)	Item #1B	ME016002	MJ012004A1
UB-			Wheel Mt. (4 Bolt)	Rear Port (7/8" O-Ring; Radial)	Item #1B	ME016002	MJ012003A1
ME-			Standard Mount (4 Bolt)	Rear Port (Manifold; Radial)	Item #1B	ME016001J1	MJ012004A1
UE-			Wheel Mt. (4 Bolt)	Rear Port (Manifold; Radial)	Item #1B	ME016001J1	MJ012003A1
P*-			SAE B (4 Bolt)	Rear Port Only	Item #1B		MJ012008A1
K*-			SAE CC (4 Bolt)	Rear Port Only	Item #1B		MJ012019A1

COUPLING SHAFT GROUP	EXPLODED VIEW							
	ITEM #	12	12A	12B	12C	12D	12E	12F
	DESCRIPTION	COUPLING SHAFT	KEY	NUT	WASHER	7/8-14x1.250 BOLT	LOCK WASHER	RETAINING RING
19-	1 3/8" Tapered Shaft	MJ019011						
31-	1-1/2" Tapered Shaft	MJ019000	039046* (3/8x1)	025131				
32-	1-1/2" Straight Key	MJ019001	039040** (3/8x1.43)		028492	021483	028966	401464
36-	17 Tooth Spline	MJ019002						
62-	14 Tooth Spline	MJ019007						
73-	17 Tooth Spline M12 Tap	MJ019009						





EXPLODED VIEW										
ITEM #		<sup>2</sup> 1, 1A, 1B, 1C	2	3	4	16	<sup>6</sup> 21 & 22	<sup>4,6</sup> 22	<sup>6</sup> 23	<sup>6</sup> 24
DESCRIPTION		BOLT (7)	END COVER	COMMUTATOR SEAL	SEAL RING (5)	INNER SEAL	PLUG & O-RING ASSEMBLY			
							O-RING	SPRING (2)	VALVE	
AAAA	Black Paint	Item #1	ME016000	032435	032819	032836				
AAAC	Corrosion Resistant Paint	Item #1	ME016000	032435	032819	032836				
AAAF	Castle Nut Replacing Patch Lock Nut	Item #1	ME016000	032435	032819	032836				
AAAG	Fluorocarbon Seals Black Paint	Item #1	ME016000	032435	032820	032836				
AAAH	Fluorocarbon Seals No Paint	Item #1	ME016000	032435	032820	032836				
AAAT	Hot Oil Shuttle Endcover 11:00	Item #1A	<sup>6</sup> ME016003A1	032435	032819	032836	036297	032790	401642	415563
AAAU	Hot Oil Shuttle Endcover 11:00 & Castle Nut	Item #1A	<sup>6</sup> ME016003A1	032435	032819	032836	036297	032790	401642	415563
OPTION GROUP	BBBA	1000 PSI Cross Port Relief Endcover	Item #1C	<sup>6</sup> ME016004A1	032435	032819	032836	411063A1	032424	410009-40, 1000PSI
	BBBB	2000 PSI Cross Port Relief Endcover	Item #1C	<sup>6</sup> ME016004A2	032435	032819	032836	411063A1	032424	410009-09, 2000PSI
	BBBC	3000 PSI Cross Port Relief Endcover	Item #1C	<sup>6</sup> ME016004A3	032435	032819	032836	411063A1	032424	410009-13, 3000PSI
	BBBD	4000 PSI Cross Port Relief Endcover	Item #1C	<sup>6</sup> ME016004A4	032435	032819	032836	411063A1	032424	410009-16, 4000PSI
	BBBG	1500 PSI Cross Port Relief Endcover	Item #1C	ME016004A5	032435	032819	032836	411063A1	032424	410009-07, 1500PSI
	BBCG	2500 PSI Cross Port Relief Endcover	Item #1C	ME016004A6	032435	032819	032836	411063A1	032424	410009-11, 2500PSI

For reverse timed manifold, use ME015001.

<sup>1</sup> Service housing ass'y ITEM #18 with part number suffix-A1 includes ITEM #13, #14 two req'd, #15 and #19.

<sup>2</sup> Select the required bolt number in designated "DISPLACEMENT GROUP" under bolt ITEM #1, 1A, 1B or 1C shown in designated "OPTION GROUP."

<sup>3</sup> 1-20 UNEF slotted nut #025133 is required if the designated "OPTION GROUP" is AAAF, AAAN, or AAAU.

<sup>4</sup> ITEM #22 is part of plug & o-ring assy's but can be serviced separately.

<sup>5</sup> Service and cover ME016001J1 includes two #032790 o-rings, ITEM 18A on the exploded ass'y view that can also be serviced separately.

<sup>6</sup> End cover assembly item #2 also includes item #21, #22, #24 and if required item #23. All but item #21 can be serviced separately.

<sup>7</sup> ME018001A1 commutator ass'y. is required if the designated "OPTION GROUP" is AAAM, AAAN, or AAAP.

Standard seal kit #SK000115 includes six #032819 seal rings, #032435 commutator seal, #032836 inner seal, #028537 and #028538 backup washers, #478063 dirt & water, #406018 grease pack, bulletin #050016.

**Chart Use Example:**

TL0240US080AAAB Torqmotor™ includes part numbers listed to the right of TL (SERIES), 0240 (DISP.), US (MOUNTING/PORTING), 08 (SHAFT), 0 (ROTATION), and AAAB (OPTION) shown in the left hand column of the chart.

**Caution:**

The charted component service information is for the Torqmotors listed only. Refer to the original equipment manufacturer of the equipment using the Torqmotor for assembly numbers not listed below.

**EXPLODED VIEW**

ITEM #	5 & 6	7	11	'13	'14	'15	17	'19	20	25
DESCRIPTION	COMMUTATOR ASSEMBLY	MANIFOLD (see note)	THRUST BEARING	INNER BEARING	THRUST WASHER(2)	THRUST BEARING	BACKUP WASHER	OUTER BEARING	DIRT & WATER SEAL	BACKUP WASHER
TL- Service Part #	ME018000A1	TL015000	068024	071031	028024	069017	028515	068027	478035	029118

**EXPLODED VIEW <sup>2</sup>(SELECT ITEM # BOLT PER OPTION GROUP)**

ITEM #	1, 1B or 1C	8A	10	9		
DISPLACEMENT (in <sup>3</sup> /rev)	BOLT (7)	ROTOR THICKNESS	ROTOR SET	DRIVE LINK	DRIVE LINK "LENGTH"	WEAR PLATE
0140-	8.6	021271 021387 -----	<b>.6271</b>	TL097003	TL123001	<b>4.77014</b>
0195-	12.0	021326 021379 -----	<b>.8768</b>	TL127003	TL123001	<b>4.77342</b>
0240-	14.5	021390 021291 021387	<b>1.0643</b>	TL157003	TL153001	<b>4.77342</b>
0280-	17.1	021352 021476 021271	<b>1.2518</b>	TL187003	TL183001	<b>4.77342</b>
0310-	18.9	021272 -----	<b>1.3738</b>	TL197003	TL193001	<b>4.77342</b>
0360-	22.2	021340 -----	<b>1.6238</b>	TL237003	TL233001	<b>4.77342</b>

Mounting Code  
Porting Code

**EXPLODED VIEW**

ITEM #	'18	2	
DESCRIPTION	SERVICE HOUSING ASS'Y	REAR COVER	
US- Wheel Mt. (4 Bolt)	7/8" O-Ring	TL012000A1	ME016000
LS- Wheel Mt. Front Brake Nose	7/8" O-Ring	TL012001A1	ME016000
UB- Wheel Mt. (4 Bolt)	7/8" Rear Radial	TL012002A1	ME016002

**EXPLODED VIEW**

ITEM #	12	12A	12B	12C	12D	12E	12F
DESCRIPTION	COUPLING SHAFT	KEY	NUT	WASHER	5/8-18 BOLT	LOCK WASHER	RETAINING RING
08- 1.25" Tapered Shaft	TL019000	038016*(5/16 x 1.00) <sup>3</sup>	025126	028413	021482	028992	401333
03- 1.25" Str. Keyed 5/8-18 Int. Thd.	TL019003						

**EXPLODED VIEW**

ITEM #	<sup>2</sup> 1, 1A, 1B, 1C	2	3	4	16
DESCRIPTION	BOLT (7)	END COVER	COMMUTATOR SEAL	SEAL RING (5)	INNER SEAL
AAWM Black Paint	Item #1	TL016000	032439	032819	032818
AAWL No Paint	Item #1	TL016000	032439	032819	032818

Shaft seal #16, can be replaced without replacing back up ring, #17, or backup washer, #25. Inspect items #17 and #25 to be sure wear or corrosion has not affected these parts. If not, remove the old shaft seal, noting position and direction of seal lip. To replace the new shaft seal, use only fingers (tools not required) and replace the seal from the rear of the motor.

If corrosion or wear is a problem and item #17 and #25 must be replaced, the factory recommends replacing the entire housing assembly (TL012xxx0A1).

For reverse timed manifold, use TL015001.

<sup>1</sup> Service housing assembly ITEM #18 with part number suffix-A1 includes ITEM #13, #14, #14, #16, #17, #18, #19, #20 & #25.

<sup>2</sup> Select the required bolt number in designated "DISPLACEMENT GROUP" under bolt ITEM #1, 1A, 1B or 1C shown in designated "OPTION GROUP."

<sup>3</sup> 1-20 UNEF slotted nut #025113 is required on 1-1/4" tapered shaft if the designated "OPTION GROUP" is AAAF, AAAN, or AAAU.

Standard seal kit #SK000212 includes six #032819 seal rings (buna), #032439 High Temp commutator seal, #032818 inner seal fluorocarbon and #478035 dirt & water seal, 406018 grease pack and bulletin #050073.

Shaft nuts are zinc dichromate.

## Preparation Before Disassembly

- Before you disassemble the Torqmotor™ unit or any of its components read this entire manual. It provides important information on parts and procedures you will need to know to service the Torqmotor™.
- Determine the type of end construction from the alternate views shown on the exploded view.
- The Series TF, TG, TL & TH Torqmotors™ will have a 5 inch (127.9 mm) main body outside diameter and seven 3/8 24 UNF 2A cover bolts.
- Refer to “Tools and Materials Required for Services” section for tools and other items required to service the Torqmotor™ and have them available.
- Thoroughly clean off all outside dirt, especially from around fittings and hose connections, before disconnecting and removing the Torqmotor™. Remove rust or corrosion from coupling shaft.
- Remove coupling shaft connections and hose fittings and immediately plug port holes and fluid lines.
- Remove the Torqmotor™ from system, drain it of fluid and take it to a clean work surface.
- Clean and dry the Torqmotor™ before you start to disassemble the unit.
- As you disassemble the Torqmotor™ clean all parts, except seals, in clean petroleum-based solvent, and blow them dry.

**WARNING:** petroleum-base solvents are flammable. Be extremely careful when using any solvent. Even a small explosion or fire could cause injury or death.

**WARNING:** WEAR EYE PROTECTION AND BE SURE TO COMPLY WITH OSHA OR OTHER MAXIMUM AIR PRESSURE REQUIREMENTS.

**CAUTION:** Never steam or high pressure wash hydraulic components. Do not force or abuse closely fitted parts.

- Keep parts separate to avoid nicks and burrs.
- Discard all seals and seal rings as they are removed from the Torqmotor™. Replace all seals, seal rings and any damaged or worn parts with genuine Parker or OEM approved service parts.

## Reference Exploded Assembly View

- Place Torqmotor in a vise**
1. Place the Torqmotor™ in a soft jawed vise, with coupling shaft (12) pointed down and the vise jaws clamping firmly on the sides of the housing (18) mounting flange or port bosses. Remove manifold port O-Rings (18A) if applicable.

**WARNING** **WARNING:** IF THE TORQMOTOR™ IS NOT FIRMLY HELD IN THE VISE, IT COULD BE DISLODGED DURING THE SERVICE PROCEDURES, CAUSING INJURY.

- Scribe alignment mark & loose valve plugs**
2. Scribe an alignment mark down and across the Torqmotor™ components from end cover (2) to housing (18) to facilitate reassembly orientation where required. Loosen two shuttle or relief valve plugs (21) for disassembly later if included in end cover. 3/16 or 3/8 inch Allen wrench or 1 inch hex socket required. SEE FIGURES 2 & 3.

- Remove special bolts & inspect bolts**
3. Remove the seven special ring head bolts (1, 1A, 1B, or 1C) using an appropriate 9/16 inch size socket. SEE FIGURE 4. Inspect bolts for damaged threads, or sealing rings, under the bolt head. Replace damaged bolts. SEE FIGURE 5.

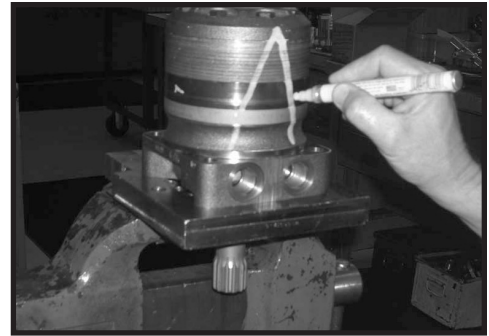

Figure 2

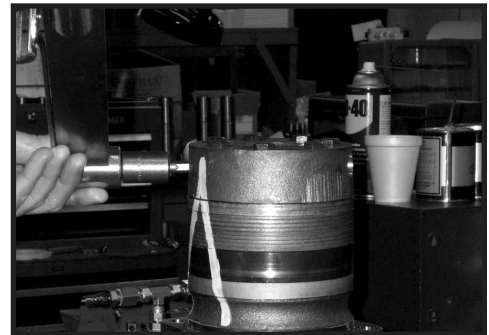

Figure 3



Figure 4



Figure 5

**Remove end cover & inspect bolts**

4. Remove end cover assembly (2) and seal ring (4). Discard seal ring. SEE FIGURE 6.

**NOTE**

**NOTE: Refer to the appropriate “alternate cover construction” on the exploded view to determine the end cover construction being serviced.**

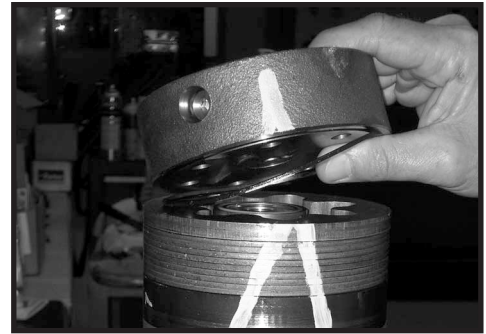

Figure 6

**Remove plugs and valves**

5. If the end cover (2) is equipped with shuttle valve or relief valve (24) components, remove the two previously loosened plugs (21) and o-rings (22). SEE FIGURE 7.

**CAUTION**

**CAUTION: Be ready to catch the shuttle valve or relief valve components that will fall out of the end cover valve cavity when the plugs are removed.**

**NOTE**

**NOTE: O-ring (22) is not included in seal kits but serviced separately if required.**

**NOTE**

**NOTE: The insert and if included the orifice plug in the end cover (2) must not be removed as they are serviced as an integral part of the end cover.**

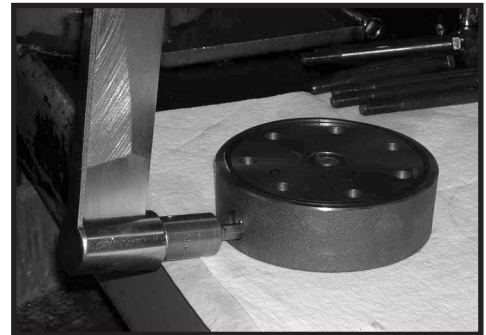

Figure 7

**Wash & inspect end cover**

6. Thoroughly wash end cover (2) in proper solvent and blow dry. Be sure the end cover valve apertures, including the internal orifice plug, are free of contamination. Inspect end cover for cracks and the bolt head recesses for good bolt head sealing surfaces. Replace end cover as necessary. SEE FIGURE 8.

**NOTE**

**NOTE: A polished pattern (not scratches) on the cover from rotation of the commutator (5) is normal. Discoloration would indicate excess fluid temperature, thermal shock, or excess speed and require system investigation for cause and close inspection of end cover, commutator, manifold, and rotor set.**

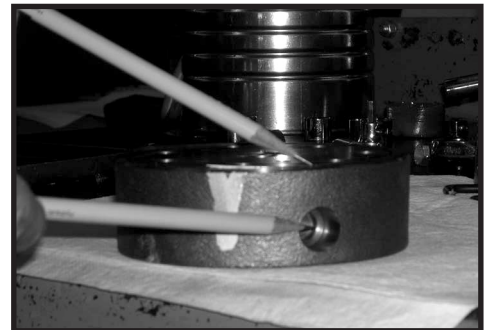

Figure 8

**Remove & inspect commutator ring**

7. Remove commutator ring (6). SEE FIGURE 9. Inspect commutator ring for cracks, or burrs.



Figure 9



**Remove & inspect commutator**

8. Remove commutator (5) and seal ring (3) Remove seal ring from commutator, using an air hose to blow air into ring groove until seal ring is lifted out and discard seal ring. Inspect commutator for cracks or burrs, wear, scoring, spalling or brinelling. If any of these conditions exist, replace commutator and commutator ring as a matched set. SEE FIGURE 10 & 11.



Figure 10

**Remove manifold**

9. Remove manifold (7) and inspect for cracks surface scoring, brinelling or spalling. Replace manifold if any of these conditions exist. SEE FIGURE 12. A polished pattern on the ground surface from commutator or rotor rotation is normal. Remove and discard the seal rings (4) that are on both sides of the manifold.



Figure 11

**NOTE**

**NOTE: The manifold is constructed of plates bonded together to form an integral component not subject to further disassembly for service. Compare configuration of both sides of the manifold to ensure that same surface is reassembled against the rotor set.**

**Remove & inspect rotor set & wearplate**

10. Remove rotor set (8) and wearplate (9), together to retain the rotor set in its assembled form, maintaining the same rotor vane (8C) to stator (8B) contact surfaces. SEE FIGURE 13. The drive link (10) may come away from the coupling shaft (12) with the rotor set, and wearplate. You may have to shift the rotor set on the wearplate to work the drive link out of the rotor (8A) and wearplate. SEE FIGURE 14. Inspect the rotor set in its assembled form for nicks, scoring, or spalling on any surface and for broken or worn splines. If the rotor set component requires replacement, the complete rotor set must be replaced as it is a matched set. Inspect the wearplate for cracks, brinelling, or scoring. Discard seal ring (4) that is between the rotor set and wearplate.



Figure 12

**NOTE**

**NOTE: The rotor set (8) components may become disassembled during service procedures. Marking the surface of the rotor and stator that is facing UP, with etching ink or grease pencil before removal from Torqmotor™ will ensure correct reassembly of rotor into stator and rotor set into Torqmotor™. Marking all rotor components and mating spline components for exact repositioning at assembly will ensure maximum wear life and performance of rotor set and Torqmotor™.**



Figure 13

**NOTE**

**NOTE:** Series TG or TH may have a rotor set with two stator halves (8B & 8D) with a seal ring (4) between them and two sets of seven vanes (8C & 8E). Discard seal ring only if stator halves become disassembled during the service procedures.



Figure 14

**NOTE**

**NOTE:** A polished pattern on the wear plate from rotor rotation is normal.

**Check rotor, vane clearance**

- Place rotor set (8) and wear plate (9) on a flat surface and center rotor (8A) in stator (8B) such that two rotor lobes (180 degrees apart) and a roller vane (8C) centerline are on the same stator centerline. Check the rotor lobe to roller vane clearance with a feeler gage at this common centerline. If there is more than .005 inches (0.13 mm) of clearance, replace rotor set. SEE FIGURE 15.

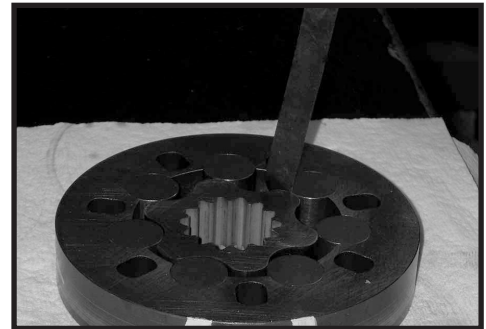

Figure 15

**NOTE**

**NOTE:** If rotor set (8) has two stator halves (8B & 8D) and two sets of seven vanes (8C & 8E) as shown in the alternate construction TG rotor set assembly view, check the rotor lobe to roller vane clearance at both ends of rotor.

**Remove & inspect drive link**

- Remove drive link (10) from coupling shaft (12) if it was not removed with rotor set and wear plate. Inspect drive link for cracks and worn or damaged splines. No perceptible lash (play) should be noted between mating spline parts. SEE FIGURE 16. Remove and discard seal ring (4) from housing (18).



Figure 16

**Remove thrust bearing**

- Remove thrust bearing (11) from top of coupling shaft. Inspect for wear, brinelling, corrosion and a full complement of retained rollers. SEE FIGURE 17.

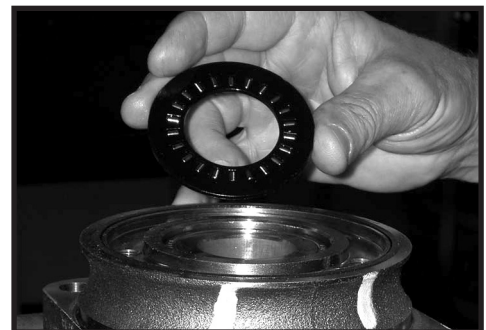

Figure 17

**Check coupling shaft for rust or corrosion**

14. Check exposed portion of coupling shaft (12) to be sure you have removed all signs of rust and corrosion which might prevent its withdrawal through the seal and bearing. Crocus cloth or fine emery paper may be used. SEE FIGURE 18. Remove any key (12A), nut (12B), washer (12C), bolt (12D), lock washer (12E), or retaining ring (12F).

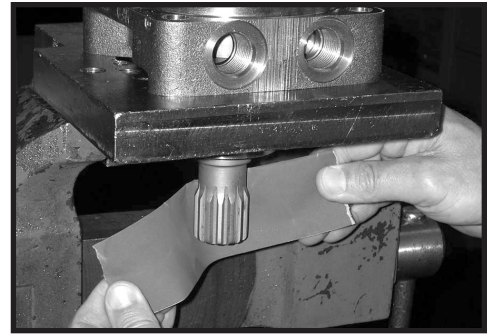

Figure 18

**Remove & inspect coupling shaft**

15. Remove coupling shaft (12), by pushing on the output end of shaft. SEE FIGURE 19. Inspect coupling shaft bearing and seal surfaces for spalling, nicks, grooves, severe wear or corrosion and discoloration. Inspect for damaged or worn internal and external splines or keyway. SEE FIGURE 20. Replace coupling shaft if any of these conditions exist.



Figure 19

**NOTE**

**NOTE: Minor shaft wear in seal area is permissible. If wear exceeds .020 inches (0.51 mm) diametrically, replace coupling shaft.**

**NOTE**

**NOTE: A slight “polish” is permissible in the shaft bearing areas. Anything more would require coupling shaft replacement.**



Figure 20

**Remove seal ring from housing**

16. Remove and discard seal ring (4) from housing (18).



**Remove shaft seal, backup washer & backup ring**

17. Remove shaft seal (16), backup ring (17), and backup washer (25) from housing by working them around unseated thrust washers (14) and thrust bearing (15) and out of the housing. Discard seal and washers. SEE FIGURE 21.

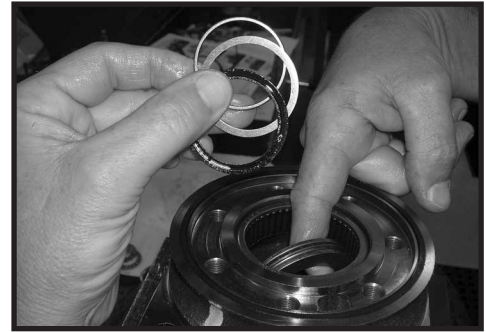

Figure 21

**NOTE**

**NOTE: The original design units of Torqmotors™ did not include backup washer (25), but must include backup washer (25) when reassembled for service.**

**Remove dirt & water seal**

18. Remove housing (18) from vise, invert it and remove and discard dirt & water seal (20). A blind hole bearing or seal puller is required. SEE FIGURE 22.



Figure 22

**Inspect housing assembly**

19. Inspect housing (18) assembly for cracks, the machined surfaces for nicks, burrs, brinelling or corrosion. Remove burrs that can be removed without changing dimensional characteristics. Inspect tapped holes for thread damage. SEE FIGURE 23. If the housing is defective in these areas, discard the housing assembly.

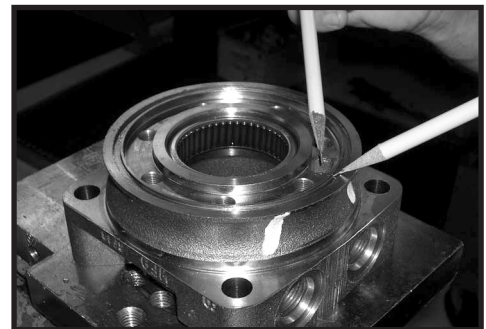

Figure 23

**Inspect housing bearing**

20. If the housing (18) assembly has passed inspection to this point, inspect the housing bearings (19) and (13) and if they are captured in the housing cavity the two thrust washers (14) and thrust bearing (15). The bearing rollers must be firmly retained in the bearing cages, but must rotate and orbit freely. All rollers and thrust washers must be free of brinelling and corrosion. SEE FIGURE 24. A bearing, or thrust washer that does not pass inspection must be replaced. If the housing has passed this inspection the disassembly of the Torqmotor™ is completed.



**Figure 24**

**NOTE**

**NOTE: The depth or location of bearing (13) in relation to the housing wear plate surface and the depth or location of bearing (19) in relation to the beginning of bearing counter bore should be measured and noted before removing the bearings. This will facilitate the correct reassembly of new bearings. SEE FIGURE 25.**

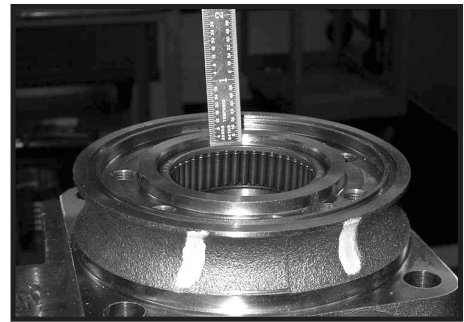

**Figure 25**

**Remove bearings and thrust washers**

21. If the bearings or thrust washers must be replaced use a suitable size bearing puller to remove bearing (19) and (13) from housing (18) without damaging the housing. Remove thrust washers (14) and thrust bearing (15) and inspect. SEE FIGURES 26 & 27.



**Figure 26**



**Figure 27**

THE DISASSEMBLY OF TORQMOTOR™ IS COMPLETED.

- Replace all seals and seal rings with new ones each time you reassemble the Torqmotor™ unit. Lubricate all seals and seal rings with SAE 10W40 oil or clean grease before assembly.
- **NOTE: Individual seals and seal rings as well as a complete seal kit are available. SEE FIGURE 28. The parts should be available through most OEM parts distributors or Parker approved Torqmotor™ distributors. (Contact your local dealer for availability).**
- **NOTE: Unless otherwise indicated, do not oil or grease parts before assembly.**
- Wash all parts in clean petroleum-based solvents before assembly. Blow them dry with compressed air. Remove any paint chips from mating surfaces of the end cover, commutator set, manifold rotor set, wear plate and housing and from port and sealing areas.

**WARNING**

**WARNING: SINCE THEY ARE FLAMMABLE, BE EXTREMELY CAREFUL WHEN USING ANY SOLVENT. EVEN A SMALL EXPLOSION OR FIRE COULD CAUSE INJURY OR DEATH.**

**WARNING**

**WARNING: WEAR EYE PROTECTION AND BE SURE TO COMPLY WITH OSHA OR OTHER MAXIMUM AIR PRESSURE REQUIREMENTS.**



Figure 28

**Place housing into soft-jawed vise**

1. Clamp the housing into a soft-jawed vise or similar support with the coupling shaft bore down, clamping against the mounting flange.

**Press in outer bearing**

2. If the housing (18) bearing components were removed for replacement, thoroughly coat and pack a **new** outer bearing (19) with clean corrosion resistant grease recommended in the material section. Press the new bearing into the counterbore at the mounting flange end of the housing, using the appropriate sized bearing mandrel such as described in figure 1 or figure 2 which will control the bearing depth.

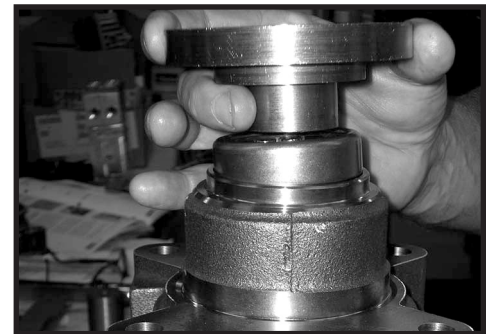

Figure 29

Torqmotor™ housings require the use of the bearing mandrel shown in figure 2 to press bearing (19) into the housing to a required depth of .290/.310 inches (7.37/7,87 mm) from the outside end of the bearing counterbore. SEE FIGURE 29.

Series TH Torqmotor housings require the use of a bearing mandrel. Consult factory for specifications.

**NOTE**                      **NOTE:** Bearing mandrel must be pressed against the lettered end of bearing shell. Take care that the housing bore is square with the press base and the bearing is not cocked when pressing a bearing into the housing.

**CAUTION**                      **CAUTION:** If the bearing mandrel specified in the “Tools and Materials Required for Servicing” section is not available and alternate methods are used to press in bearing (13) and (19) the bearing depths specified must be achieved to insure adequate bearing support and correct relationship to adjacent components when assembled.

**CAUTION**                      **CAUTION:** Because the bearing (13) and (19) have a press fit into the housing they must be discarded when removed. They must not be reused.

- Press in dirt & water seal**
3. Press a **new** dirt and water seal (20) into the housing (18) outer bearing counterbore.
- The dirt and water seal (20) must be pressed in with the lip facing out and until the seal is flush to .020 inches (.51 mm) below the end of housing. SEE FIGURE 30.



Figure 30

**Place housing assembly into vise**

4. Invert housing (18) assembly into a soft jawed vise with the coupling shaft bore down, clamping against the mounting flange. SEE FIGURE 31.

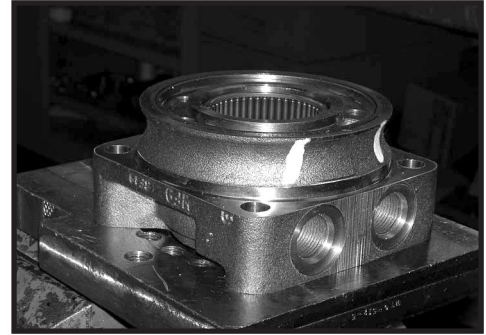

Figure 31

**Press in inner bearing**

5. The Torqmotor™ housing (18) requires that you assemble a **new** backup ring (17), **new** backup washer (25) & a **new** shaft seal (16), with the lip facing to the inside of Torqmotor (see figure 69A), thrust washer (14), thrust bearing (15) and a second thrust washer (14) in that order before pressing in the inner housing bearing (13). SEE FIGURE 32 & 33. When these components are in place, press **new** bearing (13) into the housing (18) to a depth of .105/.125 inches (2.67/3.18) below the housing wear plate contact face. Use the opposite end of the bearing mandrel used to press in outer bearing (19). Reference figure 2, in the “Tools and Materials Required for Servicing” section. SEE FIGURE 34.



Figure 32



Figure 33



Figure 34



**Assemble backup washer & seal** 6. A housing (18) that did not require replacement of the bearing package will require that the two “captured” thrust washers (14) and thrust bearing (15) be unseated and vertical to the counterbore and the **new** backup ring (17), **new** backup washer (25), and **new** seal (16) be worked around the thrust bearing package and placed into their respective counterbores. The seal lip must face out of the seal counterbore and toward the inside of Torqmotor™ (see figure 60). Be sure the thrust bearing package is resealed correctly after assembly of the seal and backup washer. SEE FIGURES 35 & 36.

**CAUTION**

**CAUTION: Original design TF & TG Torqmotors™ that do not have backup washer (25) when disassembled must be assembled with a new backup ring (17), new backup washer (25), and new seal (16).**

**Apply masking tape to shaft**

7. Apply masking tape around splines or keyway on shaft (12) to prevent damage to seal. SEE FIGURE 37.



Figure 35

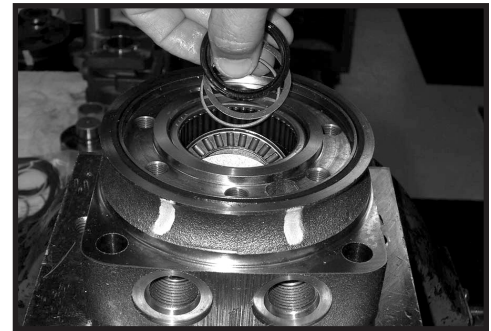

Figure 36

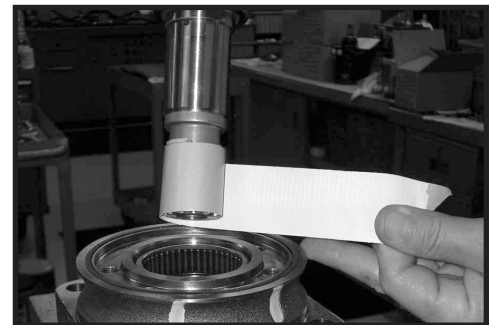

Figure 37

- Install coupling shaft**
8. Be sure that a generous amount of clean corrosion resistant grease has been applied to the lower (outer) housing bearing (19). Install the coupling shaft (12) into housing (18), seating it against the second thrust washer (14). SEE FIGURE 38.

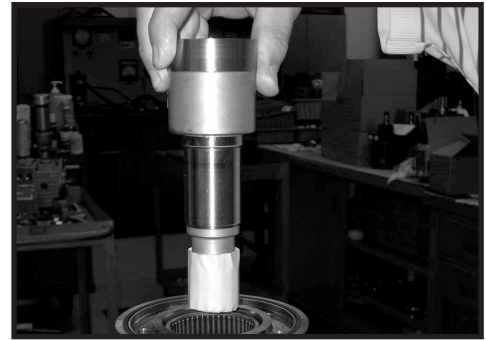

Figure 38

**CAUTION**

**CAUTION: The outer bearing (19) is not lubricated by the system's hydraulic fluid. Be sure it is thoroughly packed with the recommended grease, Parker Gear grease specification #045236, E/M Lubricant #K-70M.**

**NOTE**

**NOTE: Mobil Mobilith SHC ® 460  
NOTE: A 102 Tube (P/N 406010) is included in each seal kit.**

**NOTE**

**NOTE: The coupling shaft (12) will be approximately .10 inch (2.54 mm) below the housing wear plate surface to allow the assembly of thrust bearing (11). The coupling shaft must rotate smoothly on the thrust bearing package. SEE FIGURE 39.**



Figure 39

- Install thrust bearing**
9. Install thrust bearing (11) onto the end of coupling shaft (12) only if you are servicing. SEE FIGURE 40.



Figure 40

- Insert seal ring**
10. Apply a small amount of clean grease to a **new** seal ring (4) and insert it into the housing (18) seal ring groove. SEE FIGURE 41.



Figure 41

- Install drive link** 11. Install drive link (10) the long splined end down into the coupling shaft (12) and engage the drive link splines into mesh with the coupling shaft splines. SEE FIGURE 42.

**NOTE** **NOTE: Use any alignment marks put on the coupling shaft and drive link before disassembly to assemble the drive link splines in their original position in the mating coupling shaft splines.**



Figure 42

- Assemble wear plate and seal ring** 12. Assemble wear plate (9) over the drive link (10) and alignment studs onto the housing (18). SEE FIGURE 43.

Apply a small amount of clean grease to a new seal ring (4) and assemble it into the seal ring groove on the wear plate side of the rotor set stator (8B). SEE FIGURE 44.

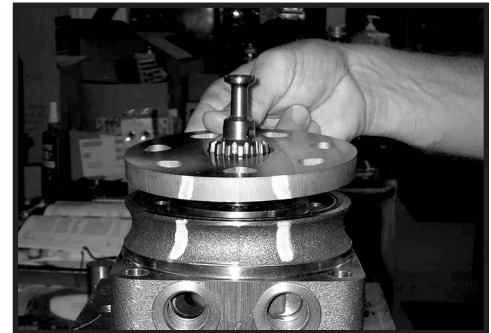

Figure 43

- Install the assembled rotor set and seal ring** 13. Install the assembled rotor set (8) onto wear plate (9) with rotor (8A) counterbore and seal ring side down and the splines into mesh with the drive link splines. SEE FIGURE 45.

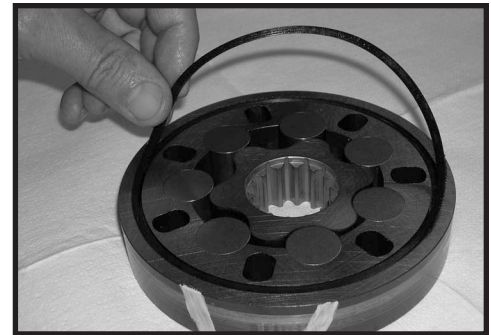

Figure 44

**NOTE** **NOTE: If necessary, go to the appropriate, "Rotor Set Component Assembly Procedure."**

**NOTE** **NOTE: The rotor set rotor counterbore side must be down against wear plate for drive link clearance and to maintain the original rotor-drive link spline contact. A rotor set without a counterbore and that was not etched before disassembly can be reinstalled using the drive link spline pattern on the rotor splines if apparent, to determine which side was down. The rotor set seal ring groove faces toward the wear plate (9).**



Figure 45



Apply clean grease to a **new** seal ring (4) and assemble it in the seal ring groove in the rotor set contact side of manifold (7). SEE FIGURE 46.

**NOTE**

**NOTE: The manifold (7) is made up of several plates bonded together permanently to form an integral component. The manifold surface that must contact the rotor set has it's series of irregular shaped cavities on the largest circumference or circle around the inside diameter. The polished impression left on the manifold by the rotor set is another indication of which surface must contact the rotor set.**

**Install manifold and seal ring**

14. Assemble the manifold (7) over the drive link (10) and onto the rotor set. Be sure the correct manifold surface is against the rotor set. SEE FIGURE 47.

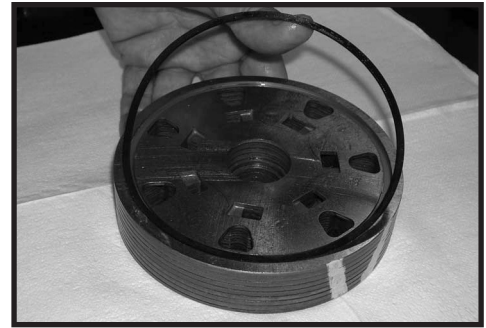

Figure 46

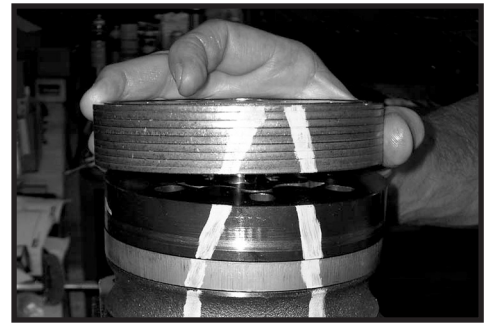

Figure 47

Apply grease to a **new** seal ring (4) and insert it in the seal ring groove exposed on the manifold. SEE FIGURE 48.



Figure 48

**Install commutator ring**

15. Assemble the commutator ring (6) onto the manifold. SEE FIGURE 49.



Figure 49

**Assemble seal & commutator**

16. Assemble a **new** seal ring (3) flat side up, into commutator (5) and assemble commutator over the end of drive link (10) onto manifold (7) with seal ring side up. SEE FIGURES 50 and 51.



Figure 50

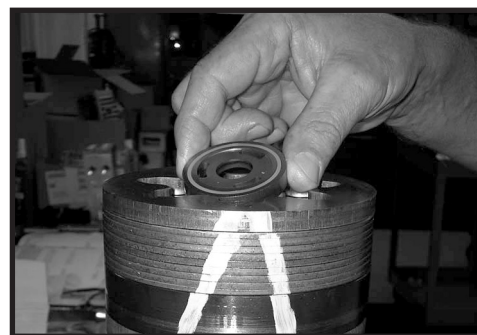

Figure 51

**Assemble shuttle valve parts into end cover**

17. If shuttle valve components items #21, #22, #23, #24 were removed from the end cover (2) turn a plug (21) with a **new** o-ring (22), loosely into one end of the valve cavity in the end cover. Insert a spring (23) the valve (24) and the second spring (23) into the other end of the valve cavity. Turn the second plug (21) with a **new** o-ring (22) loosely into the end cover valve cavity. 3/16 inch Allen wrench required. SEE FIGURE 52.

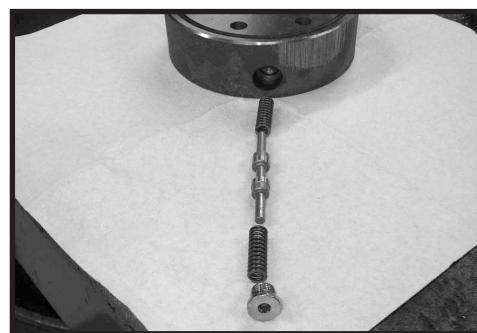

Figure 52

**Assemble relief valve parts in end cover**

18. If relief valve components items #21, #22, #24 were removed from the end cover (2) assemble a **new** o-ring (22) on the two plugs (21). Assemble a two piece relief valve (24) in each of the plugs, with the large end of the conical spring into the plug first and the small nut of the other valve piece in the small end of the conical spring. Turn each of the plug and relief valve assemblies into the end cover loosely to be torqued later. 3/8 inch Allen or 1 inch Hex socket required. SEE FIGURE 53.

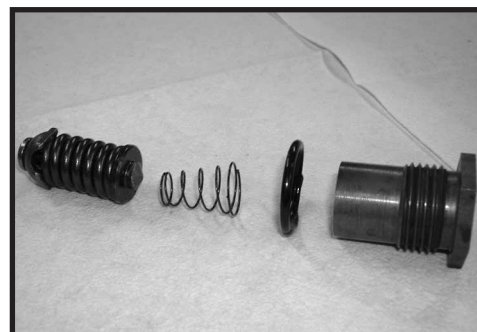

Figure 53

**Assemble seal ring & end cover**

19. Assemble a **new** seal ring (4) into end cover (2) and assemble end cover onto the commutator set. SEE FIGURES 54 and 55.

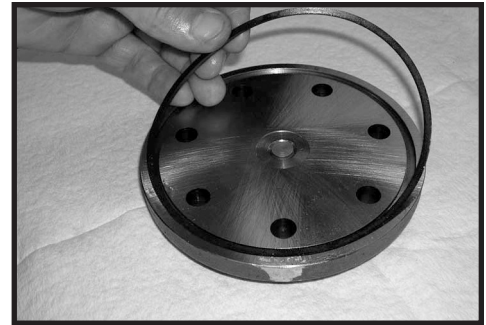

Figure 54

**NOTE**

**NOTE:** If the end cover has a valve (24), use the line you previously scribed on the cover to radially align the end cover into its original position.



Figure 55

**Assemble cover bolts**

20. Assemble the 7 special bolts (1, 1A, 1B or 1C) and screw in finger tight. Alternately and progressively tighten the bolts to pull the end cover and other components into place with a final torque of 50-55 ft. lbs. (68-75 N m) for the seven 3/8-24 threaded bolts. SEE FIGURES 56, 57 and 58.

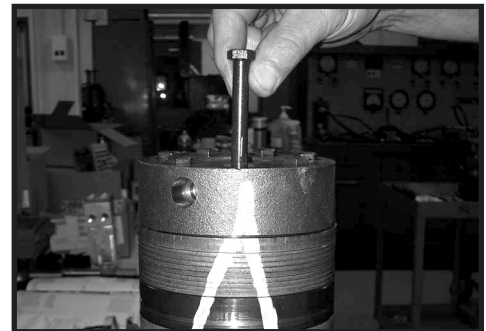

Figure 56

**NOTE**

**NOTE:** The special bolts required for use with the relief or shuttle valve (24) end cover assembly (2) are longer than the bolts required with standard and cover assembly. Refer to the individual service parts lists or parts list charts for correct service part number if replacement is required.

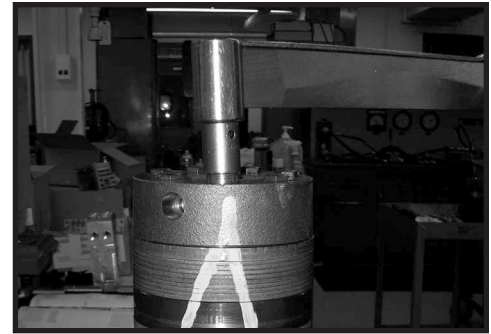

Figure 57

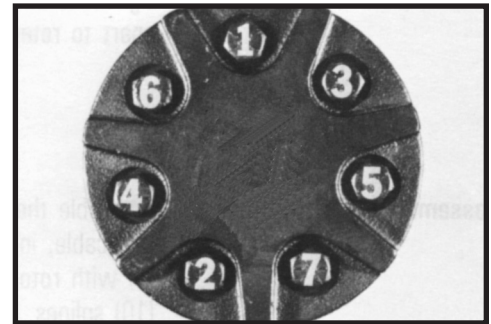

Figure 58

**Torque the valve plugs**

- 21. Torque the two shuttle valve plug assemblies (21) in end cover assembly to 9-12 ft. lbs. (12-16 N m) if cover is so equipped. SEE FIGURE 59.

Torque the two relief valve plug assemblies (21) in end cover assembly to 45-55 ft. lbs. (61-75 N m) if cover is so equipped.



Figure 59

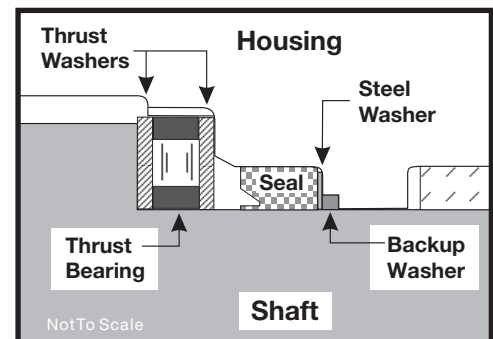

Figure 60

THE ASSEMBLY OF THE TORQMOTOR™ IS NOW COMPLETE EXCEPT FOR WOODRUFF KEY (12A), NUT (12B), WASHER (12C), BOLT (12D), LOCKWASHER (12E), RETAINER RING (12F) or PORT O-RINGS (18A) AT INSTALLATION IF APPLICABLE. PROCEED TO FINAL CHECKS SECTION.



## One Piece Stator Construction

A disassembled rotor (8A) stator (8B) and vanes (8C) that cannot be readily assembled by hand can be assembled by the following procedures.

**Assemble stator** 1. Place stator (8B) onto wear plate (9) with seal ring (4) side down, after following Torqmotor™ assembly procedures 1 through 13. Be sure the seal ring is in place. SEE FIGURE 62.

**Insert two bolts** 2. If assembly alignment studs are not being utilized, align stator bolt holes with wear plate and housing bolt holes and turn two bolts (1) finger tight into bolt holes approximately 180 degrees apart to retain stator and wear plate stationary.

**Assemble rotor** 3. Assemble the rotor (8A), counterbore down if applicable, into stator (8B), and onto wear plate (9) with rotor splines into mesh with drive link (10) splines. SEE FIGURE 63.

### NOTE

**NOTE: If the manifold side of the rotor was etched during Torqmotor disassembly, this side should be up. If the rotor is not etched and does not have a counterbore, use the drive link spline contact pattern apparent on the rotor splines to determine the rotor side that must be against the wear plate.**

**Assemble vanes** 4. Assemble six vanes (8C), or as many vanes that will readily assemble into the stator vane pockets. SEE FIGURE 64.

### CAUTION

**CAUTION: Excessive force used to push the rotor vanes into place could shear off the coating applied to the stator vane pockets.**

**Assemble full complement of vanes** 5. Grasp the output end of coupling shaft (12) with locking pliers or other appropriate turning device and rotate coupling shaft, drive link and rotor to seat the rotor and the assembled vanes (8C) into stator (8B), creating the necessary clearance to assemble the seventh or full complement of seven vanes. Assemble the seven vanes using minimum force. SEE FIGURE 65.

**Remove two assembled bolts** 6. Remove the two assembled bolts (1) if used to retain stator and wear plate.

Go to Torqmotor™ assembly procedure #15, to continue Torqmotor™ assembly.



Figure 62

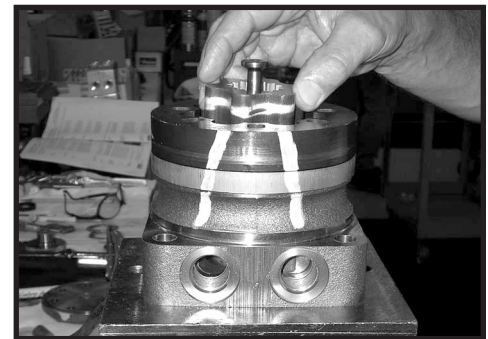

Figure 63



Figure 64



Figure 65

## Two Piece Stator Construction

A disassembled rotor set (8) that cannot be readily assembled by hand and has a two piece stator can be assembled by the following procedures.

- Assemble stator halves**
1. Place stator half (8B) onto wear plate (9) with seal ring (4) side down, after following Torqmotor™ assembly procedures 1 through 13. Be sure the seal ring is in place.
- Insert two alignment studs**
2. Align stator bolt holes with wear plate and housing bolts and turn two alignment studs finger tight into bolt holes approximately 180 degrees apart to retain stator half and wear plate stationary.
- Assemble rotor**
3. Assemble rotor (8A), counterbore down if applicable, into stator half (8B), and onto wear plate (9) with rotor splines into mesh with drive link (10) splines.

### NOTE

**NOTE: Use any marking you applied to rotor set components to reassemble the components in their original relationship to ensure ultimate wear life and performance.**

- Assemble vanes**
4. Assemble six vanes (8C), or as many vanes that will readily assemble into the stator vane pockets.

### CAUTION

**CAUTION: Excessive force used to push the rotor vanes into place could shear off the coating applied to the stator vane pockets.**

- Assemble full complement of vanes**
5. Grasp the output end of coupling shaft (12) with locking pliers or other appropriate turning device and rotate coupling shaft, drive link and rotor to seat the rotor and the assembled vanes (8C) into stator half (8B), creating the necessary clearance to assemble the seventh or full complement of seven vanes. Assemble the seven vanes using minimum force.

- Assemble seal ring in stator half**
6. Place second stator half (8D) on a flat surface with seal ring groove up. Apply a small amount of grease to a **new** seal ring (4) and assemble it into stator half ring groove.

- Assemble second stator half**
7. Assemble the second stator half (8D) over the two alignment studs and rotor (8A) with seal ring side down onto the first stator half (8B) aligning any timing marks applied for this purpose.

**CAUTION**

**CAUTION: If the stator half (8B) is a different height (thickness) than stator half (8D) the stator vanes (8C) or (8E) of the same length (height) as the stator half must be reassembled in their respective stator half for the rotor set to function properly.**

- Assemble vanes**
8. Assemble six vanes (8E), or as many vanes that will readily assemble into the stator vane pockets.

- Assemble full complement of vanes**
9. Grasp the output end of coupling shaft (12) with locking pliers or other appropriate turning device and rotate coupling shaft, drive link and rotor to seat the rotor and the assembled vanes (8E) into stator (8D), creating the necessary clearance to assemble the seventh or full complement of seven vanes. Assemble the seven vanes using minimum force.

Go to Torqmotor™ assembly procedure #15, to continue Torqmotor™ assembly.

---

## Final Checks

- Pressurize the Torqmotor™ with 100 p.s.i. dry air or nitrogen and submerge in solvent to check for external leaks.
- Check Torqmotor™ for rotation. Torque required to rotate coupling shaft should not be more than 50 ft. lbs. (68 N m)
- Pressure port with “B” cast under it on housing (18) is for clockwise coupling shaft rotation as viewed from the output end of coupling shaft. Pressure port with “A” case under it is for counter clockwise coupling shaft rotation.
- Use test stand if available, to check operation of the Torqmotor™.

## Hydraulic Fluid

Keep the hydraulic system filled with one of the following:

- 10W40 SE or SF manufacturers suggested oil.
- Hydraulic fluid as recommended by equipment manufacturer, but the viscosity should not drop below 50 SSU or contain less than .125% zinc anti-wear additives.

**CAUTION: Do not mix oil types. Any mixture, or an unapproved oil, could deteriorate the seals. Maintain the proper fluid level in the reservoir. When changing fluid, completely drain old oil from the system. It is suggested also that you flush the system with clean oil.**

## Filtration

Recommended filtration 40-50 micron.

## Oil Temperature

Maximum operating temperature 200°F (93.3° C).



**Tips****Tips for Maintaining the Torqmotor™ Hydraulic System**

- Adjust fluid level in reservoir as necessary.
- Encourage all operators to report any malfunction or accident that may have damaged the hydraulic system or component.
- Do not attempt to weld any broken Torqmotor™ component. Replace the component with original equipment only.
- Do not cold straighten, hot straighten, or bend any Torqmotor™ part.
- Prevent dirt or other foreign matter from entering the hydraulic system. Clean the area around and the filler caps before checking oil level.
- Investigate and correct any external leak in the hydraulic system, no matter how minor the leak.
- Comply with manufacturer's specifications for cleaning or replacing the filter.

**CAUTION: Do not weld, braze, solder or any way alter any Torqmotor™ component.**

**CAUTION: Maximum operating pressure must not exceed recommended Torqmotor™ pressure capacity.**

**CAUTION: Always carefully inspect any system component that may have been struck or damaged during operation or in an accident. Replace any component that is damaged or that is questionable.**

**CAUTION: Do not force any coupling onto the Torqmotor™ coupling shaft as this could damage the unit internally.**

Parker extends close technical cooperation and assistance. If problems occur which you cannot solve, please contact your local Parker approved Distributor or Parker Technical Support. Our phone number and fax number and address are on the back cover of this manual.



# Torqmotor™ Service Procedure TF, TG, TH and TL Series

## Offer of Sale

The items described in this document and other documents and descriptions provided by Parker Hannifin Corporation, its subsidiaries and its authorized distributors ("Seller") are hereby offered for sale at prices to be established by Seller. This offer and its acceptance by any customer ("Buyer") shall be governed by all of the following Terms and Conditions. Buyer's order for any item described in its document, when communicated to Seller verbally, or in writing, shall constitute acceptance of this offer. All goods, services or work described will be referred to as "Products".

**1. Terms and Conditions.** Seller's willingness to offer Products, or accept an order for Products, to or from Buyer is subject to these Terms and Conditions or any newer version of the terms and conditions found on-line at [www.parker.com/saleterms/](http://www.parker.com/saleterms/). Seller objects to any contrary or additional terms or conditions of Buyer's order or any other document issued by Buyer.

**2. Price Adjustments; Payments.** Prices stated on Seller's quote or other documentation offered by Seller are valid for 30 days, and do not include any sales, use, or other taxes unless specifically stated. Unless otherwise specified by Seller, all prices are F.C.A. Seller's facility (INCOTERMS 2010). Payment is subject to credit approval and is due 30 days from the date of invoice or such other term as required by Seller's Credit Department, after which Buyer shall pay interest on any unpaid invoices at the rate of 1.5% per month or the maximum allowable rate under applicable law.

**3. Delivery Dates; Title and Risk; Shipment.** All delivery dates are approximate and Seller shall not be responsible for any damages resulting from any delay. Regardless of the manner of shipment, title to any products and risk of loss or damage shall pass to Buyer upon placement of the products with the shipment carrier at Seller's facility. Unless otherwise stated, Seller may exercise its judgment in choosing the carrier and means of delivery. No deferment of shipment at Buyers' request beyond the respective dates indicated will be made except on terms that will indemnify, defend and hold Seller harmless against all loss and additional expense. Buyer shall be responsible for any additional shipping charges incurred by Seller due to Buyer's acts or omissions.

**4. Warranty.** Seller warrants that the Products sold hereunder shall be free from defects in material or workmanship for a period of eighteen months from the date of delivery to Buyer or 2,000 hours of normal use, whichever occurs first. The prices charged for Seller's products are based upon the exclusive limited warranty stated above, and upon the following disclaimer: **DISCLAIMER OF WARRANTY: THIS WARRANTY COMPRISES THE SOLE AND ENTIRE WARRANTY PERTAINING TO PRODUCTS PROVIDED HEREUNDER. SELLER DISCLAIMS ALL OTHER WARRANTIES, EXPRESS AND IMPLIED, INCLUDING DESIGN, MERCHANTABILITY AND FITNESS FOR A PARTICULAR PURPOSE.**

**5. Claims; Commencement of Actions.** Buyer shall promptly inspect all Products upon delivery. No claims for shortages will be allowed unless reported to the Seller within 10 days of delivery. No other claims against Seller will be allowed unless asserted in writing within 30 days after delivery. Buyer shall notify Seller of any alleged breach of warranty within 30 days after the date the defect is or should have been discovered by Buyer. Any action based upon breach of this agreement or upon any other claim arising out of this sale (other than an action by Seller for an amount due on any invoice) must be commenced within 12 months from the date of the breach without regard to the date breach is discovered.

**6. LIMITATION OF LIABILITY.** UPON NOTIFICATION, SELLER WILL, AT ITS OPTION, REPAIR OR REPLACE A DEFECTIVE PRODUCT, OR REFUND THE PURCHASE PRICE. IN NO EVENT SHALL SELLER BE LIABLE TO BUYER FOR ANY SPECIAL, INDIRECT, INCIDENTAL OR CONSEQUENTIAL DAMAGES ARISING OUT OF, OR AS THE RESULT OF, THE SALE, DELIVERY, NON-DELIVERY, SERVICING, USE OR LOSS OF USE OF THE PRODUCTS OR ANY PART THEREOF, OR FOR ANY CHARGES OR EXPENSES OF ANY NATURE INCURRED WITHOUT SELLER'S WRITTEN CONSENT, EVEN IF SELLER HAS BEEN NEGLIGENT, WHETHER IN CONTRACT, TORT OR OTHER LEGAL THEORY. IN NO EVENT SHALL SELLER'S LIABILITY UNDER ANY CLAIM MADE BY BUYER EXCEED THE PURCHASE PRICE OF THE PRODUCTS.

**7. User Responsibility.** The user, through its own analysis and testing, is solely responsible for making the final selection of the system and Product and assuring that all performance, endurance, maintenance, safety and warning requirements of the application are met. The user must analyze all aspects of the application and follow applicable industry standards and Product information. If Seller provides Product or system options, the user is responsible for determining that such data and specifications are suitable and sufficient for all applications and reasonably foreseeable uses of the Products or systems.

**8. Loss to Buyer's Property.** Any designs, tools, patterns, materials, drawings, confidential information or equipment furnished by Buyer or any other items which become Buyer's property, will be considered obsolete and may be destroyed by Seller after two consecutive years have elapsed without Buyer ordering the items manufactured using such property. Seller shall not be responsible for any loss or damage to such property while it is in Seller's possession or control.

**9. Special Tooling.** A tooling charge may be imposed for any special tooling, including without limitation, dies, fixtures, molds and patterns, acquired to manufacture Products. Such special tooling shall be and remain Seller's property notwithstanding payment of any charges by Buyer. In no event will Buyer acquire any interest in apparatus belonging to Seller which is utilized in the manufacture of the Products, even if such apparatus has been specially converted or adapted for such manufacture and notwithstanding any charges paid by Buyer. Unless otherwise agreed, Seller shall have the right to alter, discard or otherwise dispose of any special tooling or other property in its sole discretion at any time.

**10. Buyer's Obligation; Rights of Seller.** To secure payment of all sums due or otherwise, Seller shall retain a security interest in the goods delivered and this agreement shall be deemed a Security Agreement under the Uniform Commercial Code. Buyer authorizes Seller as its attorney to execute and file on Buyer's behalf all documents Seller deems necessary to perfect its security interest.

**11. Improper use and Indemnity.** Buyer shall indemnify, defend, and hold Seller harmless from any claim, liability, damages, lawsuits, and costs (including attorney fees), whether for personal injury, property damage, patent, trademark or copyright infringement

or any other claim, brought by or incurred by Buyer, Buyer's employees, or any other person, arising out of: (a) improper selection, improper application or other misuse of Products purchased by Buyer from Seller; (b) any act or omission, negligent or otherwise, of Buyer; (c) Seller's use of patterns, plans, drawings, or specifications furnished by Buyer to manufacture Product; or (d) Buyer's failure to comply with these terms and conditions. Seller shall not indemnify Buyer under any circumstance except as otherwise provided.

**12. Cancellations and Changes.** Orders shall not be subject to cancellation or change by Buyer for any reason, except with Seller's written consent and upon terms that will indemnify, defend and hold Seller harmless against all direct, incidental and consequential loss or damage. Seller may change product features, specifications, designs and availability with notice to Buyer.

**13. Limitation on Assignment.** Buyer may not assign its rights or obligations under this agreement without the prior written consent of Seller.

**14. Force Majeure.** Seller does not assume the risk and shall not be liable for delay or failure to perform any of Seller's obligations by reason of circumstances beyond the reasonable control of Seller (hereinafter "Events of Force Majeure"). Events of Force Majeure shall include without limitation: accidents, strikes or labor disputes, acts of any government or government agency, acts of nature, delays or failures in delivery from carriers or suppliers, shortages of materials, or any other cause beyond Seller's reasonable control.

**15. Waiver and Severability.** Failure to enforce any provision of this agreement will not waive that provision nor will any such failure prejudice Seller's right to enforce that provision in the future. Invalidation of any provision of this agreement by legislation or other rule of law shall not invalidate any other provision herein. The remaining provisions of this agreement will remain in full force and effect.

**16. Termination.** Seller may terminate this agreement for any reason and at any time by giving Buyer thirty (30) days written notice of termination. Seller may immediately terminate this agreement, in writing, if Buyer: (a) commits a breach of any provision of this agreement (b) appointments a trustee, receiver or custodian for all or any part of Buyer's property (c) files a petition for relief in bankruptcy on its own behalf, or by a third party (d) makes an assignment for the benefit of creditors, or (e) dissolves or liquidates all or a majority of its assets.

**17. Governing Law.** This agreement and the sale and delivery of all Products hereunder shall be deemed to have taken place in and shall be governed and construed in accordance with the laws of the State of Ohio, as applicable to contracts executed and wholly performed therein and without regard to conflicts of laws principles. Buyer irrevocably agrees and consents to the exclusive jurisdiction and venue of the courts of Cuyahoga County, Ohio with respect to any dispute, controversy or claim arising out of or relating to this agreement.

**18. Indemnity for Infringement of Intellectual Property Rights.** Seller shall have no liability for infringement of any patents, trademarks, copyrights, trade dress, trade secrets or similar rights except as provided in this Section. Seller will defend and indemnify Buyer against allegations of infringement of U.S. patents, U.S. trademarks, copyrights, trade dress and trade secrets ("Intellectual Property Rights"). Seller will defend at its expense and will pay the cost of any settlement or damages awarded in an action brought against Buyer based on an allegation that a Product sold pursuant to this Agreement infringes the Intellectual Property Rights of a third party. Seller's obligation to defend and indemnify Buyer is contingent on Buyer notifying Seller within ten (10) days after Buyer becomes aware of such allegations of infringement, and Seller having sole control over the defense of any allegations or actions including all negotiations for settlement or compromise. If a Product is subject to a claim that it infringes the Intellectual Property Rights of a third party, Seller may, at its sole expense and option, procure for Buyer the right to continue using the Product, replace or modify the Product so as to make it noninfringing, or offer to accept return of the Product and return the purchase price less a reasonable allowance for depreciation. Notwithstanding the foregoing, Seller shall have no liability for claims of infringement based on information provided by Buyer, or directed to Products delivered hereunder for which the designs are specified in whole or part by Buyer, or infringements resulting from the modification, combination or use in a system of any Product sold hereunder. The foregoing provisions of this Section shall constitute Seller's sole and exclusive liability and Buyer's sole and exclusive remedy for infringement of Intellectual Property Rights.

**19. Entire Agreement.** This agreement contains the entire agreement between the Buyer and Seller and constitutes the final, complete and exclusive expression of the terms of sale. All prior or contemporaneous written or oral agreements or negotiations with respect to the subject matter are herein merged.

**20. Compliance with Law, U.K. Bribery Act and U.S. Foreign Corrupt Practices Act.** Buyer agrees to comply with all applicable laws and regulations, including both those of the United Kingdom and the United States of America, and of the country or countries of the Territory in which Buyer may operate, including without limitation the U. K. Bribery Act, the U.S. Foreign Corrupt Practices Act ("FCPA") and the U.S. Anti-Kickback Act (the "Anti-Kickback Act"), and agrees to indemnify and hold harmless Seller from the consequences of any violation of such provisions by Buyer, its employees or agents. Buyer acknowledges that they are familiar with the provisions of the U. K. Bribery Act, the FCPA and the Anti-Kickback Act, and certifies that Buyer will adhere to the requirements thereof. In particular, Buyer represents and agrees that Buyer shall not make any payment or give anything of value, directly or indirectly to any governmental official, any foreign political party or official thereof, any candidate for foreign political office, or any commercial entity or person, for the purpose of influencing such person to purchase products or otherwise benefit the business of Seller.

2/12





**Parker Hannifin Corporation**  
2745 Snapps Ferry Road  
Greeneville, TN 37745 USA  
Tel: (423) 639-8151  
FAX: (423) 787-2418  
[www.parker.com/pumpmotor](http://www.parker.com/pumpmotor)